

735-70
THE MECHANICAL BATHY THERMOGRAPH
AN HISTORICAL REVIEW

B. K. Couper
Oceanographer
Naval Ship Systems Command
Washington, D. C. 20360

E. C. LaFond
Oceanographer
Naval Undersea R & D Center
San Diego, California 92132

ABSTRACT

Except for the mercury in glass stem thermometers, the bathythermograph (BT) has been the oceanographic instrument most often used to measure temperature in the ocean. Since its initial development in 1938 and including subsequent modifications, it has been used to acquire more than 1,300,000 continuous temperature-depth profiles in the upper layers of the sea. These data cover nearly every square mile of wide areas of the major oceans. The primary reason for rapid deployment of the BT and the voluminous acquisition of data was its use in antisubmarine warfare. The BT was designed to provide the depth of the near surface, generally mixed layer, and the underlying thermal gradients for a prediction of sonar range. A program was set up in World War II to train naval officers in the uses of the instrument and the data acquired. The data on glass slides were sent to Woods Hole Oceanographic Institution and the U. S. Navy Radio and Sound Laboratory for the preparation of sonar charts, which were printed by the U. S. Navy Hydrographic Office and issued to the fleet. These valuable data have been subsequently used in a variety of oceanographic studies. One conservative bibliography lists 700 reports concerned with BT data. Although other instruments such as the expendable BT, salinity-temperature-depth recorder (STD) and the thermistor chain are superseding the original mechanical BT, its use and the historical data that it has provided will still be with us for some time.

INTRODUCTION

The first version of the bathythermograph (BT) was invented by Dr. A. F. Spilhaus and reported in 1938.⁽¹⁾ In response to a wartime need for information useful to sonar, the instrument was improved and manufactured in quantity. Beginning with the prewar invention, a discussion is presented in this paper of the development and use of the BT: manufacture and testing; training program for observers; and collection, processing, and use of data. The paper also gives some highlights and accomplishments of what became one of the largest oceanographic surveys in history.

BACKGROUND

Previous Instruments

The term "mechanical bathythermograph," or "BT," is used to distinguish this instrument from the later electronic instrument known as the "expendable bathythermograph." Considering the extent of knowledge of temperature structure in the upper layers of the sea, measured by other instruments in use in 1937, BT development and use was a major breakthrough. At this time, the common way of measuring the temperature was to take a surface measurement with a mercury stem thermometer, and supplement it with spot measurements made with reversing thermometers attached to frames or water bottles. Measurements were made frequently at widely spaced depths of 10, 25, 50, etc. meters below the surface.

Particularly lacking was knowledge of the sharp temperature change occurring at the bottom of the so-called mixed layer, as well as the slight, gentle heating occurring at the very surface, above the isothermal layer. Even temperature inversions were questioned. With thermometers mounted several meters apart, it was only by coincidence that the predetermined depth coincided with the discontinuity layer.

Relation to Sonar

Sonar-range experiments conducted in the late 1930's by the Naval Research Laboratory at Piney Point⁽²⁾ on the Potomac River did not agree with results from sonar equipment on Navy ships off Guantanamo Bay and San Diego. Among the difficulties at sea was the problem that the ranges were shorter in the afternoon than they were in the morning, a phenomenon which became known as "afternoon effect." This led to some interesting theories. The captain of the USS SEMMES, one of the experimental ships, thought that his sonar operators were dozing off because they had eaten too much lunch, and so for three months the poor boys suffered on salad lunches. Still the ranges were shorter in the afternoon than in the morning. It is now known that the afternoon effect was caused by a warming of the surface layers as the sun reached its zenith and advanced into the afternoon period.⁽³⁾ The complicated distribution of temperature with depth, which actually exists, was simply not known in those early days and the BT was the instrument chosen to provide such information.

Work sponsored by NAVSHIPS SR 104 03 01.

The situation at Piney Point, where the ranges did not show a diurnal fluctuation in the afternoon, was caused by the sonar system and target operating in what is known as a sound channel. At sea, the downward refraction, the result of surface heating caused the sound beam from the Navy ships to dive sharply and go beneath the target, except at very short range. Scientists and naval officers both at NRL on the East Coast and at Destroyer Division 19 on the West Coast had reasoned out what must be occurring. However, other oceanographic variables were also suspected of influencing sonar ranges.⁽⁴⁾ LCDR (later RADM) Rawson Bennett, II, USN, played a critical role in identifying refraction as an important factor in World War II sonar operations.

As a result of the practical observations begun in 1930, based on weather and oceanographic phenomena in connection with sound transmission, a significant report by the Naval Research Laboratory⁽⁵⁾ on "Transmission of Sound in Sea Water; Absorption and Reflection Coefficients and Temperature Gradients," was issued in 1935. The temperature gradients discussed in the report were sometimes indicated by thermometers hung outside the eyeport of a diving submarine.

Late in 1940, a committee of the National Academy of Sciences, chaired by Dr. E. H. Colpitts, investigated the Navy's antisubmarine effort.⁽⁶⁾ One of their principal recommendations was for a study of oceanographic effects on submarine-detection equipment. A consequence of the committee's report was the awarding of one of the first Office of Scientific Research and Development (OSRD) contracts to the Woods Hole Oceanographic Institution. Columbus Iselin, Director of Woods Hole Oceanographic Institution, responsive to the Navy's need for information on water structure, was instrumental in furthering development of the BT to fulfill this requirement.

DEVELOPMENT OF THE BT

Spilhaus Bathythermograph

About 1937, Dr. A. F. Spilhaus, acting on a suggestion by Dr. C. -G. Rossby, improved a previous method of continuously measuring temperature with depth in the sea. An older device, called the "oceanograph," had been built by Rossby and Dr. Karl Lange.⁽⁷⁾ When lowered slowly into the sea, this instrument managed, by means of many linkages, to draw a graph of temperature against depth on a large, smoked brass foil (fig. 1). Spilhaus was also familiar with tiny meteorographs, instruments which preceded the radiosondes for measuring atmospheric changes. These two instruments may be considered the precursors of the mechanical bathythermograph.

Spilhaus had four major aims: a smaller, lighter design which would permit lowerings by a hand line from ships at rest or by the hydrographic winch at very slow ship speed; a rapid temperature response as the BT quickly passed through changing temperature regions; elimination of hysteresis in the pressure element; and an easily

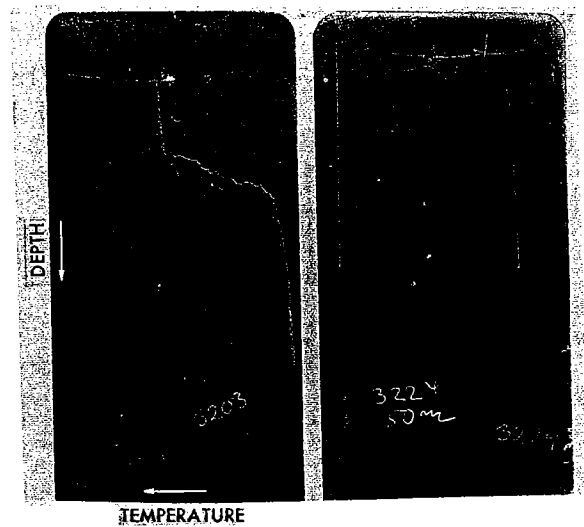

Figure 1. Oceanograph recording (after Rossby and Montgomery, 1934).

handled and evaluated record.⁽¹⁾ In accomplishing these aims, he developed a pressure element consisting of a sylvon bellows with an internal spring (similar to the capsule of an aneroid barometer). He mounted a small, smoked glass slide on the end of the bellows so that it moved vertically under the force of pressure. This feature has remained essentially unchanged. On this first model, he used a bimetallic strip, exposed to sea water, to move a stylus horizontally across the slide in accordance with temperature changes. Because the flow of water around the strip caused the stylus to vibrate, Spilhaus later substituted a Bourdon tube, shielded from the water flow, to which the stylus was attached.⁽⁸⁾ Connected to the Bourdon tube was a long, coiled tube filled with xylene (fig. 2). It responded to increasing temperature by increasing the internal pressure in the Bourdon. This caused the tube to "unwind" about a fixed axis, thus moving the stylus across the slide. It is noteworthy that linkages and pivots were avoided; only two elastically deformable elements were used.

In operation, the Spilhaus instrument was attached by a Nansen bottle clamp to the weighted, hydrographic winch wire. When maximum depth had been reached, a "messenger" could be sent down the wire to activate a "pen-lifter," a device designed to prevent the stylus from recording the uptrace (fig. 3).

Thus by 1940, a continuous record of temperature against depth, from the surface to 150 meters, could be taken in approximately 3 minutes from a ship underway and traveling at less than 7 knots. Furthermore, the records (slides) could be conveniently stacked and handled in small, slotted boxes. For analysis, Spilhaus projected the enlarged trace onto a frosted glass screen on which was superimposed a translucent calibration chart. The projector held the slide identically as in

present BT instruments, and reference marks on the slide (such as required by the oceanograph were unnecessary. The ease with which comparison of data plots could be made is apparent in figure 4, an illustration from Spilhaus' first BT paper.

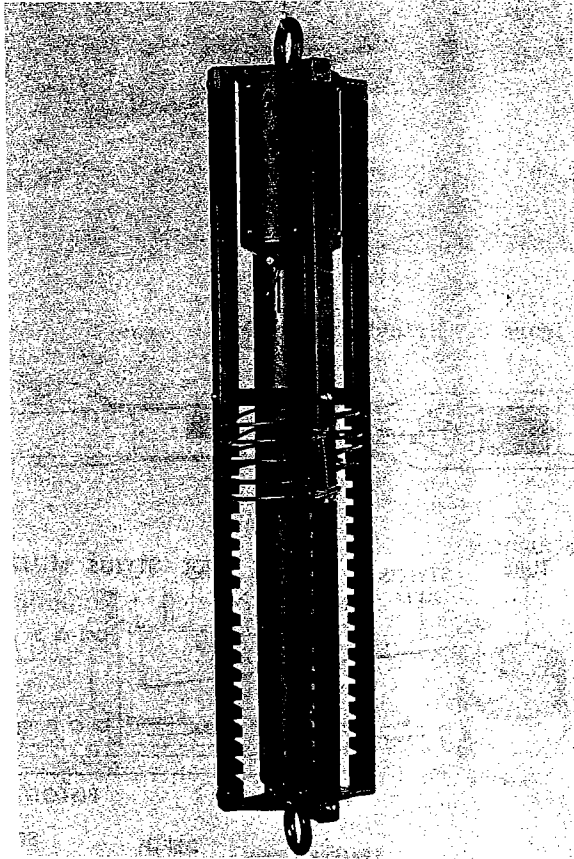

Figure 2. One model of original Spilhaus bathythermograph.

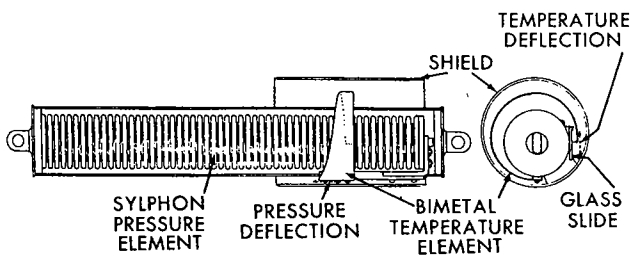

Figure 3. Design of Spilhaus bathythermograph (after Spilhaus, 1938).

The variations in temperature are shown with what was then startling clarity; these analog plots have not been improved upon in presenting summaries of temperature-depth conditions.

Spilhaus was encouraged to continue his developments by Dr. Henry Bigelow of Harvard University and Woods Hole Institution. Columbus Iselin quickly saw the application of the BT to the

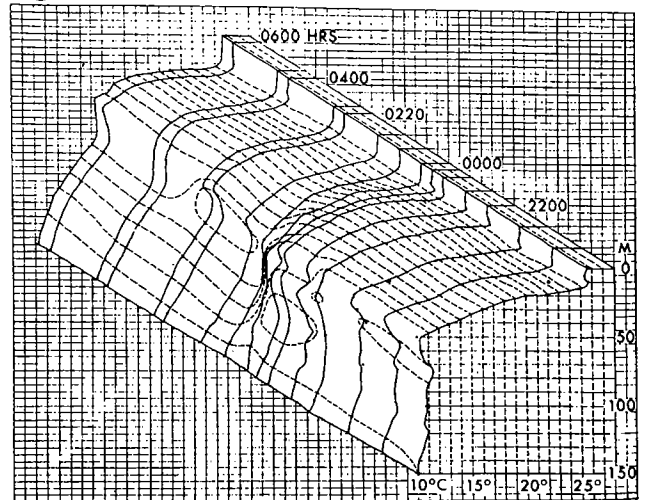

Figure 4. Temperature-depth-time structures as determined from bathythermograph traces (after Spilhaus, 1938).

sonar problem. Spilhaus, prior to being involved in meteorology during the war, participated in early (1938) antisubmarine warfare and BT tests aboard the research destroyer, USS SEMMES (DDG 18) out of New London. He also licensed the Submarine Signal Company of Boston to manufacture the instrument and a small number were constructed.⁽⁹⁾

Ewing Development

About 1940, Dr. W. Maurice Ewing, now director of the Lamont-Doherty Geological Observatory of Columbia University, together with assistance from Allyn C. Vine and Dr. J. Lamar Worzel, attacked the sonar problem under a National Defense Research Committee (OSRD) contract at Woods Hole Oceanographic Institution.* He and Iselin planned to equip merchant ships to take BT observations approximately every hour to assess the temporal and spatial temperature variability to important to the Navy. It was quickly apparent, however, that the Submarine Signal Company instrument was unsuitable. Furthermore, to meet the requirement of on-the-spot use at high military speeds, each of Spilhaus' original aims had to be modified. The instrument was packaged in streamlined form. Temperature-response time was reduced because use at a ship's speed of 15 knots required that sinking speed be increased; a special BT lightweight winch was introduced; and slide reading was done immediately on deck without benefit of projectors. Such a job would presently be called equipment (system) development, exactly the way the Navy then considered the BT-development of a component of sonar equipment, bought to equip ASW craft or to conduct surveys producing useful sonar information.

* Letter of W. M. Ewing to CAPT John E. Long, USNR (Ret.), dated June 24, 1963. Lamont-Doherty Library.

Ewing, Vine, Worzel, and a gifted metal worker, Raymond Deysher, built the first 75 BT's in the Woods Hole Oceanographic Institution shops, incorporating the features of the modern instrument and handling equipment.⁽¹⁰⁾

INSTRUMENT FEATURES

BT Assembly

The BT essentially consists of a thermal element, a pressure element, a body tube, a nosepiece, tail fins, and a body tube sleeve.⁽¹¹⁾ Its purpose is to make a graphic record of temperature against depth as the instrument is lowered or raised in the ocean (fig. 5).

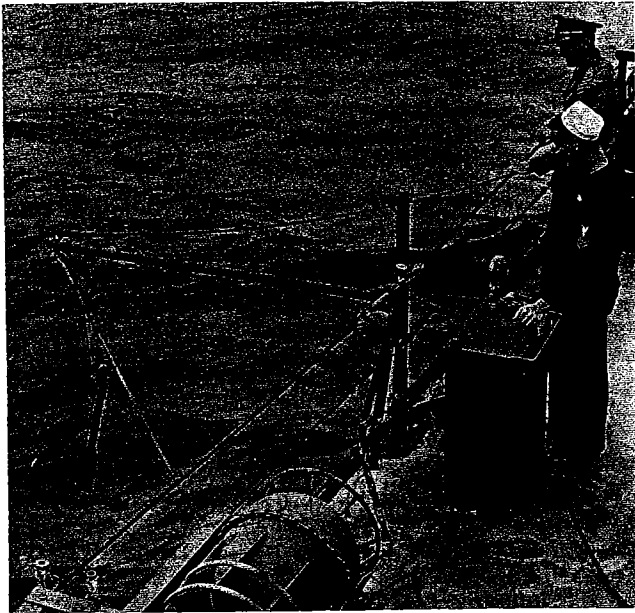

Figure 5. Lowering BT with original Navy BT winch with pipe boom.

Identities and contrasts of the present (Ewing) BT with the Spilhaus instrument are obvious (figs. 6 through 13). The smoked glass slide, slide-holder, syphon bellows and spring pressure assembly are essentially the same. The temperature-sensing, xylene-filled coil has been greatly lengthened, and is constructed of thin copper tubing, so wound as to assure maximum water circulation. Fins were added to the body tube, and a swivel to permit the wire to twist without spinning the BT.

An expanded view of the present mechanical bathythermograph is shown in figure 7. The cutaway version at the top of the figure shows the original streamlined features. The towing attachment and fins have been strengthened. The body tube housing is 2 inches in diameter and the overall length is 31-1/2 inches. It weighs approximately 21 pounds. The relative motions for temperature and depth are indicated in the lower part of the figure. The structural components are shown in figure 8, including a weighted nosepiece (or diving sleeve)

for fast diving.

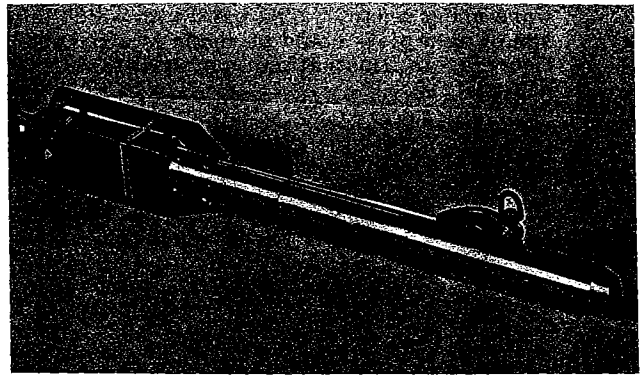

Figure 6. Bathythermograph.

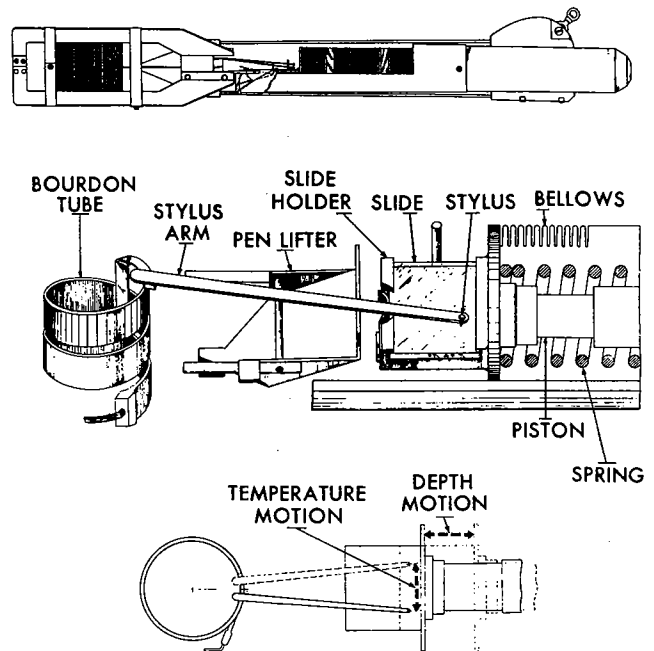
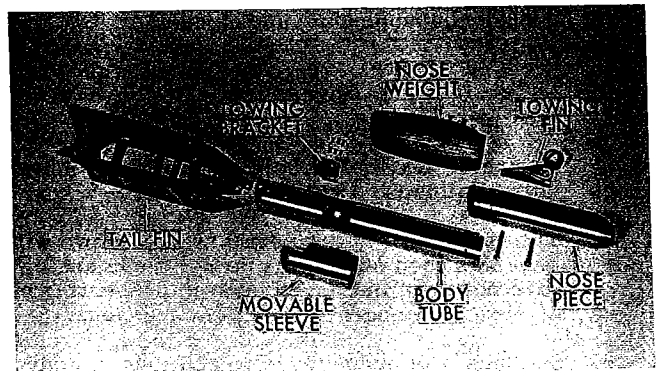

Figure 7. Cut-away of present bathythermograph.



Two types of bathythermographs were initially manufactured: a deep range (0 to 450 ft.) and a shallow depth range (0 to 180 ft.). A deeper (0 to 900 ft.) depth range instrument was later added, requiring modification of the pressure element by use of a spring external to the sylinder bellows. The depth range is controlled by the size of the spring and sylinder bellows arrangement in the pressure element.^{(11) thru (16)}

Temperature Element. The temperature element (figs. 9 and 10) consists of four parts: 45 to 50 feet of thin copper capillary tubing; a Bourdon tube; a case-compensating bimetallic coil carrying a stylus arm; and a pen lifter. The Bourdon tube is anchored to the body tube. Attached to the other end of the Bourdon tube, and free to move, is the bimetallic compensating coil carrying the stylus arm. The capillary tubing is fed into the Bourdon tube, and pressure of the xylene in the capillary is applied to the Bourdon tube. As water temperature warms the xylene in the capillary, internal pressure of the xylene increases, causing the Bourdon tube to unwind. This moves the stylus across the glass slide. The capillary tubing is wound on an hexagonal, tapered frame and extends beyond the body tube. The staggered winding insures maximum flow and contact with the water for maximum heat transfer.

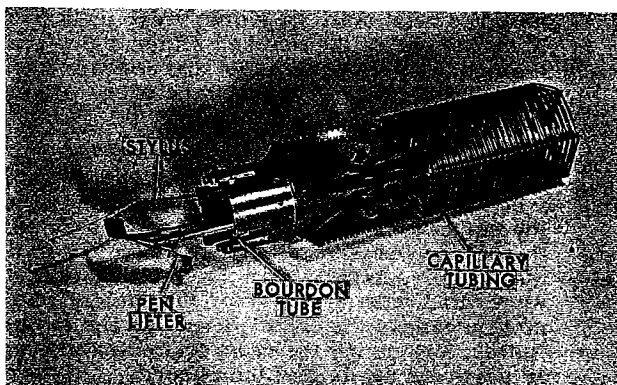

Figure 9. Temperature element assembly.

In contrast, there is only a slight flow of water around the Bourdon tube, bimetallic coil, and stylus within the free-flooding body tube. In the earliest models, it was found that the water inside the body tube and surrounding the Bourdon tube would cause a lag in the stylus (temperature) response because of a difference in temperature within the body tube with respect to temperature of the outside capillary tube. Waterscoops to increase circulation inside the body tube reduced the lag, but caused an unacceptable vibration of the stylus. The problem was satisfactorily solved early in 1941 by adding a reverse-wind, bimetallic coil between the free end of the Bourdon tube and the stylus. This addition provides the well-known Amthrop "case compensation"⁽¹⁰⁾ and the stylus position represents the average temperature of the xylene in the capillary tubing.

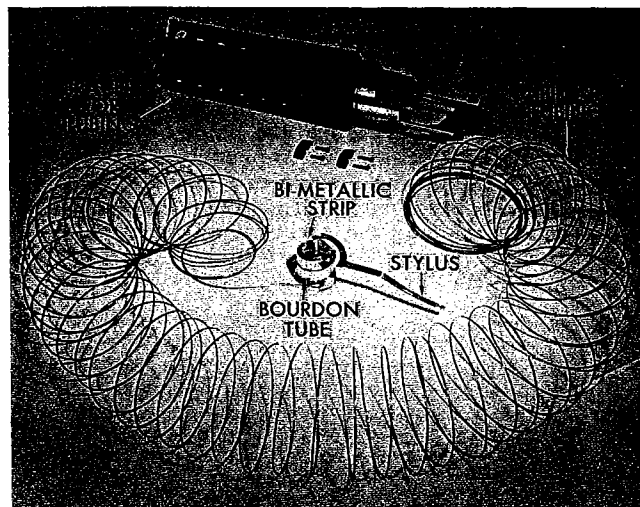
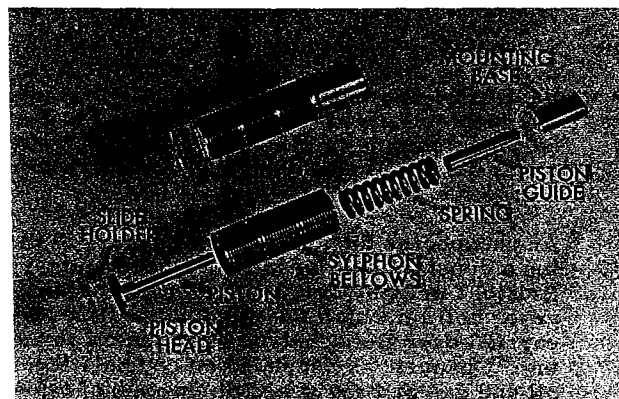

Figure 10. Thermal components.

The temperature range of the bathythermograph is from 30 to 90 °F. Temperature a few degrees below 30 °F will not harm the instrument, but temperature above 105 °F may result in a permanent set of the stylus or Bourdon tube.

The speed of response of the thermal unit should be such that when the temperature is varied from 85 to 35 °F, the stylus will move smoothly through at least two-thirds of the indicated range in less than 1 second. The instrument should be so constructed and adjusted that when it is subjected to a cycle of temperature changes and brought back to the starting point, the temperature hysteresis does not exceed 0.2 °F.

Pressure Unit. The pressure assembly including the piston, spring, sylinder bellows and slide holder have remained essentially unchanged from the Spilhaus instrument. The components are shown in figure 11. The soldered-joint, sylinder bellows keep water pressure off the spring, shaft, and inside face of the piston; however, they offer no



resistance to the longitudinal movement of the piston, caused by pressure on its outside face. With increasing water pressure (depth), the piston moves to compress the spring, and the slide holder moves longitudinally with the piston. A smoked glass slide carried in the holder thus moves longitudinally in response to pressure (depth) change, while the stylus swings crosswise in response to temperature change (fig. 12). The combined motion causes the stylus to scribe a continuous line on the smoked glass slide to give the well-known BT "trace."

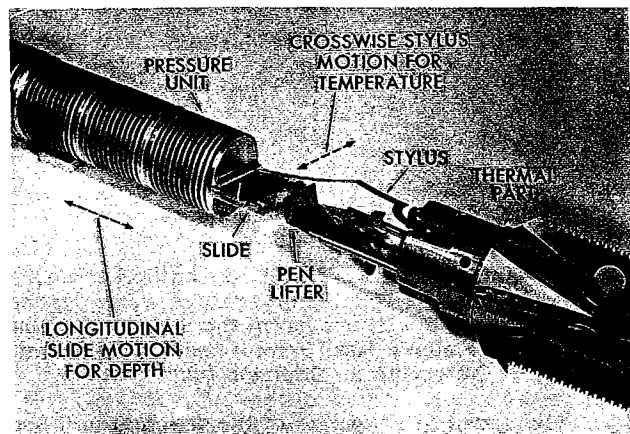

Figure 12. Pressure-temperature recording parts.

The calibrated steel spring is of such proportions that a pressure, corresponding to the maximum depth for which the BT is designed, will compress the bellows approximately 0.7 inch. The pressure unit is adjusted so that pressure hysteresis will not produce an indication of variance in excess of 2 percent of depth, that is; 2 feet per 100 ft. of depth.

Glass Slides. The glass slides are 1 x 1.75 inches and 0.033 inch thick, with one or two corners ground off for ease of insertion into the instrument and for orientation when placed on the grid (fig. 13). Failure to meet exact specifications sometimes gave trouble, especially when the thickness of the slide was not as specified and it would not fit into the holder. The slides were coated on one side with a carbon deposit, bound to the slide by a thin coating of oil. The oil initially used was skunk oil, a name which caused amusing comment among the sailors.

An unexpected difficulty was encountered in obtaining a constant quality in the smoked slides. The Bristol Company developed a small automatic conveyor belt on which the oiled glass slides were carried over Bunsen-type gas burners for smoking. Opacity depended on composition of the oil and gas and the speed of advance of the chain. Temperature and humidity of the room were also critical factors. Although airconditioning helped in later manufacturing, continuous, full-time

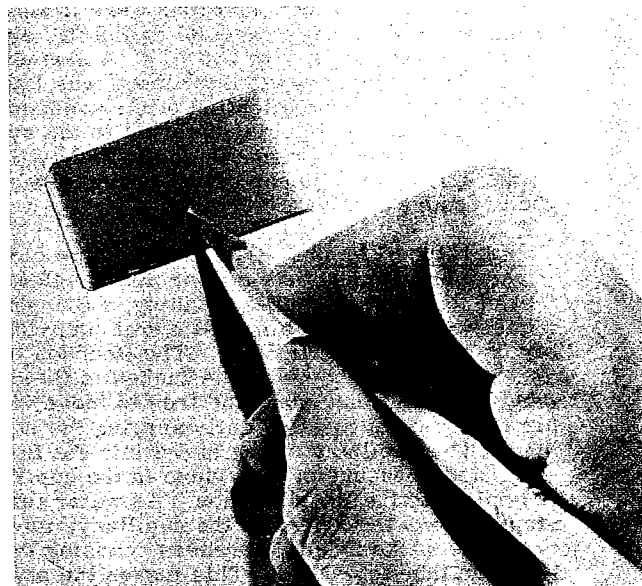

Figure 13. Glass slide.

monitoring was necessary. After the war, "gold" coated slides, prepared by thinly sputtering a metallic mist onto the glass, were used by the Navy instead of the smoked slides. However, many scientists prefer the sharper trace afforded by the old friction-free surface of the oil-smoked slide.

Pen Lifter. In operation, the BT dives rapidly in free fall to maximum depth, then soars up near the surface when the winch brake is applied. As the cable is reeled in, the BT is hauled in near the surface, usually through the turbulent surface waves and wake of the ship. Turbulent water motion causes the BT to jitter and the stylus to flutter, obscuring the down trace and preventing an accurate reading of the record.

One successful means of reducing surface trace vibration is by use of a pen lifter (fig. 7). It is actuated by the pressure movement of the slyphon bellows and may or may not be used. It is so designed that when the BT comes back up to a certain depth below the surface where most of the vibration is occurring, the pen can be lifted as the BT is retrieved. The near-surface trace on the slide is thus not obscured.

Diving Devices. A heavy, detachable nose weight that allows deeper dives at high speeds, by permitting more rapid descent, is frequently attached to the BT (fig. 8). However, this sometimes causes the dive to be too fast for the stylus to follow the true temperature on the down trace, and a false gradient can result. Another device is a diving attachment placed well aft on the BT. The towing wire is led back from the swivel through the block and under a shear pin. Towing farther aft allows the BT to "plunge" more steeply. On retrieval, the pin shears at 60 pounds, shifting the towing point back to near the nose.

Care is thus required in interpreting the near-surface trace when the diving attachment causes the instrument to "plunge" at high ship speed.

BT Accessories

BT Winch. The original Spilhaus bathythermograph was often attached to a hydrographic wire and lowered with a hydrographic winch. With the smaller device and thinner wire, a hand crank was tried. To paraphrase Ewing, "At first we modified a winch that had been used with a sounding machine lead and this was manually operated. The winch operator had to crank in a lot of wire under a fairly strong tension by hand, so we put motors on the first BT winches."

The early Navy BT winches were box shaped, with a drum on one side and control lever on another (fig. 5). With this model, it was difficult to keep the wire on the drum. Because winches were mounted on deck, they frequently took sea water inside, shorting out the motor. These early mechanisms were later replaced with a BT winch mounted on four legs to hold it off the deck. The drum and a larger motor were mounted in the center.

The standard instrument dives as nearly free fall as possible, dragging out wire as it sinks. At maximum depth, the winch brake is applied, and the BT is immediately brought up close to the surface and hauled in as previously described.

The free fall operation (as opposed to sending the instrument down on a weighted hydrographic cable) was an essential improvement by Ewing for the purpose of attaining depth at high ship speed. Design choices throughout the system were predicated on nearly free fall operation, and both friction and water drag were minimized wherever possible.

Preformed, seven-stranded, stainless steel, airplane-target towing wire $3/32$ "-diameter, afforded the essentials of strength, relatively small diameter, and semioncorrosive properties (fig. 14). The small wire diameter reduced drag in the water, and a later nylon coating helped prevent kinking. Friction was reduced through use of a ball-bearing drum spindle on the winch, and a free-running pulley with no fairleads. The cable was guided onto the drum manually without using a built-in level winder. The result was that reliable records to depths of 450 feet could be taken in 2 to 3 minutes, on a ship cruising at 15 knots.

"Power on," "power off," and "brake on," "brake off" operations had to be nearly instantaneous. Initially used was a split-pulley, V-belt drive and a brake-drum control, all linked to one lever. Although modified for higher power and ruggedness, the modern BT winch includes the same necessary features for obtaining near-friction free fall under operating conditions. Booms also improved from a single wooden spar, to steel pipe, to a gate type (fig. 16). Some ships, however, used improvised davits (fig. 15).

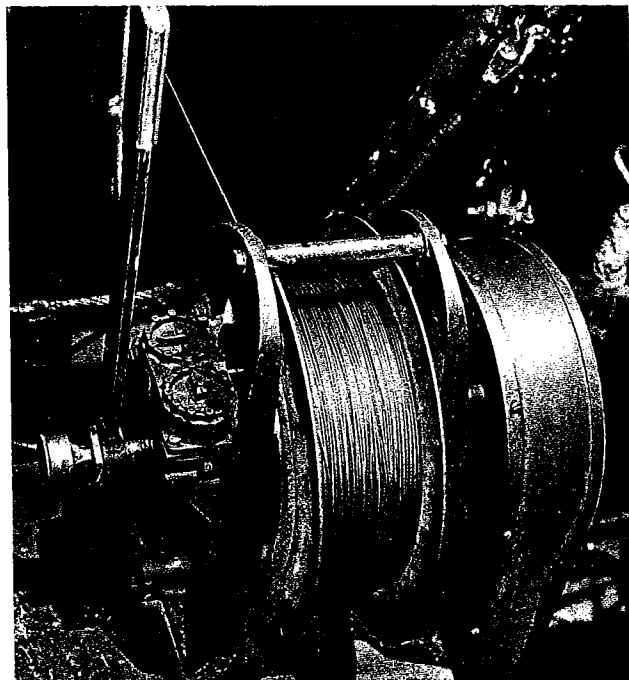

Figure 14. Drum, wire and counter on BT winch.

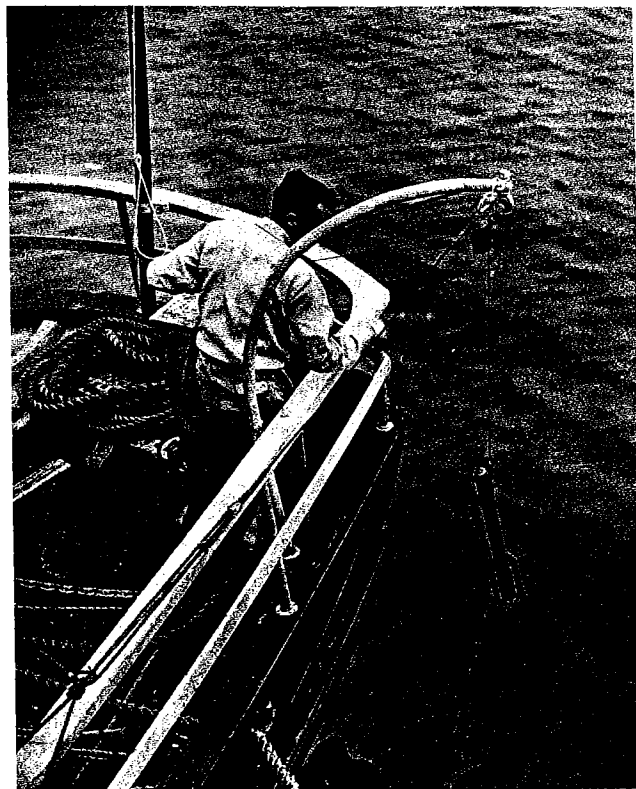

Figure 15. BT davit on R/V E.W. Scripps

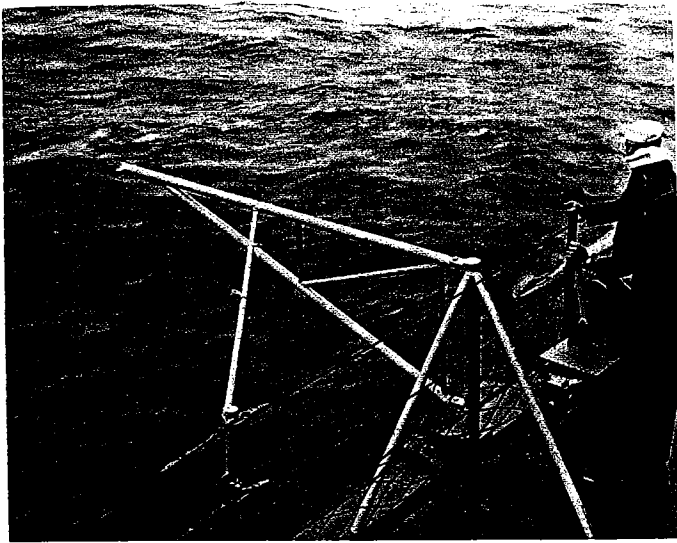

Figure 16. Gate boom for BT lowering

BT Modifications

Depth Ranges. Continued modifications and improvements were made in techniques and facilities for calibration. BT's with specific depth ranges (other than the three standard ones) were a frequent requirement. The most common requests were for shallow ranges to be used in lakes and nearshore areas (fig. 17). Thus a variety of pressure element springs were developed that could be merely inserted to replace the heavier springs required for greater depth ranges. Depth ranges of 50, 100, 200, 450, and 900 feet are now commercially available, and temperature scales may be specified either centigrade or fahrenheit.

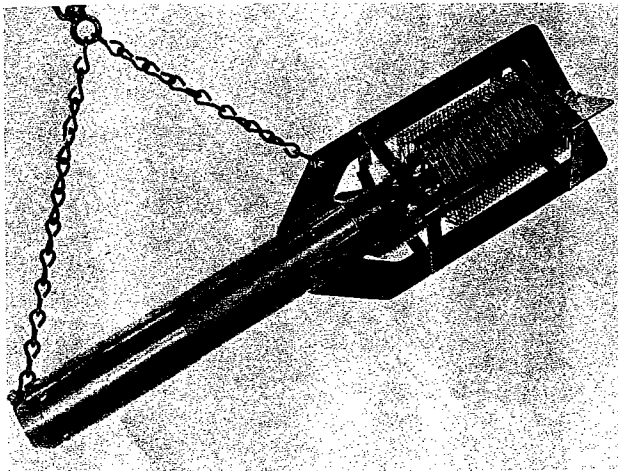

Figure 17. Shallow depth range bathythermograph is shorter because of reduced nosepiece. It is usually hung horizontally so that the temperature and pressure elements are at the same level when raised and lowered through the water.

Sediment BT. Another BT modification was an instrument for penetration of soft bottom sediment (fig. 18). This modification required an increase in the nose weight and removal of the fins. In Lake Meade, it penetrated the soft sediment to a depth of 80 feet. The bathythermogram clearly showed the sharp change in temperature gradient at the water-sediment interface, and the strong linear, positive, gradient below.

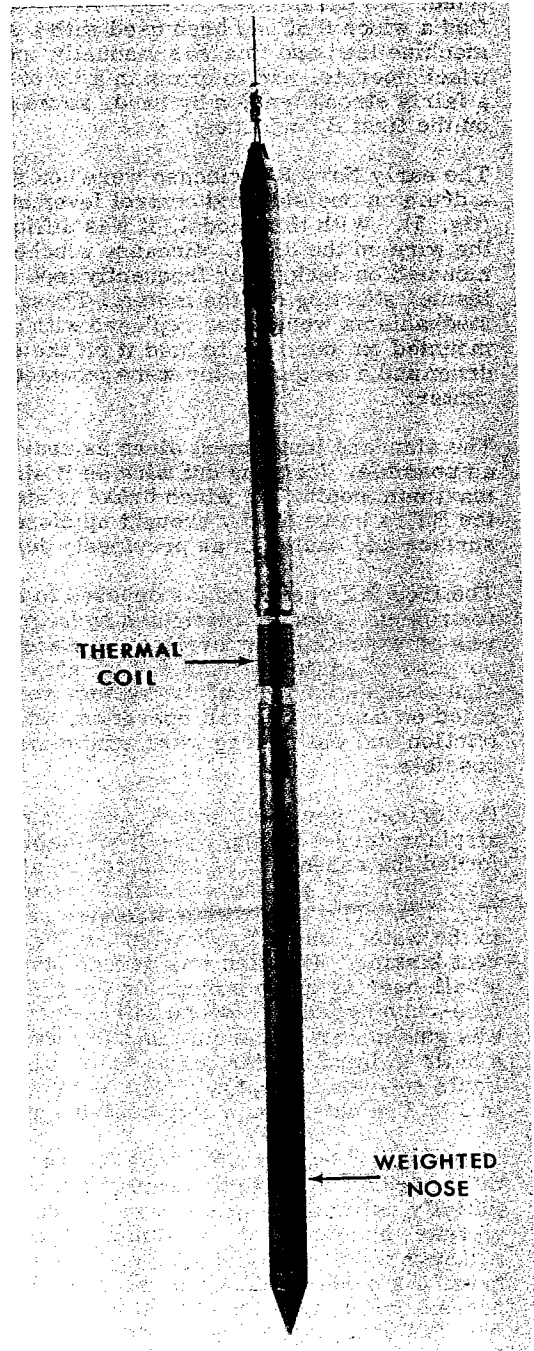

Figure 18. BT modified for penetration into soft sediment. The nose weight is increased, the fins are removed and thermal coil is recessed.

Sea Sampler. One limitation of the BT was that it measured only water temperature, and not related chemical properties. To improve its capabilities, Spilhaus added six small Nansen-type bottles and called it a sea sampler!⁽⁷⁾ The sampling bottles surrounded a cylinder which contained a releasing block operated by a BT pressure element. This instrument was extensively used in 1940 with his original bathythermograph.

With the improved BT, Spilhaus and Miller⁽¹⁸⁾ enhanced the sea sampler with 12 sampling bottles fitted closely around the body of the BT (fig. 19 A). Each bottle had its own tripping arm that was activated by the compression of the sylphon bellows and tripped at the appropriate position of the compressed spring or depth (fig. 19 B). The bottles were individually attached to the BT by a spring catch (fig. 19 C). Water samples could thus be collected at discrete, predetermined depth intervals, and at the same time a continuous temperature-depth BT trace could be obtained from a moving ship. It was also possible to collect a single sample of sea water by attaching a single water bottle called a "side saddle" to the BT. Increased tension on the towing wire at the maximum depth of lowering caused the towing pin to shear and activated valves to close the bottle (fig. 19 D).

A mouse trap type sediment sampler was attached to and used with the BT by A. R. Miller. Although this adaption performed successfully, the practice of bouncing the BT on the bottom was extremely hazardous for it.

Submarine BT. The submarine bathythermograph (SBT) may be considered a modification of the surface vessel bathythermograph. Submariners became interested in the BT for purposes of escaping detection and for indications of how to adjust trim conditions. An instrument was thus developed and subsequently installed on all submarines (fig. 20). The long, liquid tube for the temperature measurement was mounted on the outside of the submarine. The pressure spring was activated by water coming into the instrument through a valve in the hull. The recording instrument in the submarine was installed in the control room, easily accessible to the conning officer, but it usually jutted out where everyone bumped his head on it.

The urgent requirement for the SBT was pointed up by the fact that the first instrument was delivered for testing and use just 2 weeks after Ewing received an admiral's request for it.

PRODUCTION CONTRACTS

After it had been established that temperature structure was useful to the Navy, BT's were purchased in quantity and installed on ASW and other ship types which ranged widely throughout the seas. Contracts for the manufacture of the bathythermograph were let, not for an instrument but for a component of sonar equipment. Rawson Bennett, one of those responsible for recognizing the "afternoon effect," and head of the Sonar Design Branch, worked very closely with the oceanographic establishments. B. K. Couper was assigned technical



Figure 19. BT modified to collect water samples.
 A. BT sampler.
 B. Mechanics of BT sampler.
 C. Installing sample bottles on BT sampler.
 D. BT with "side saddle" sampler.

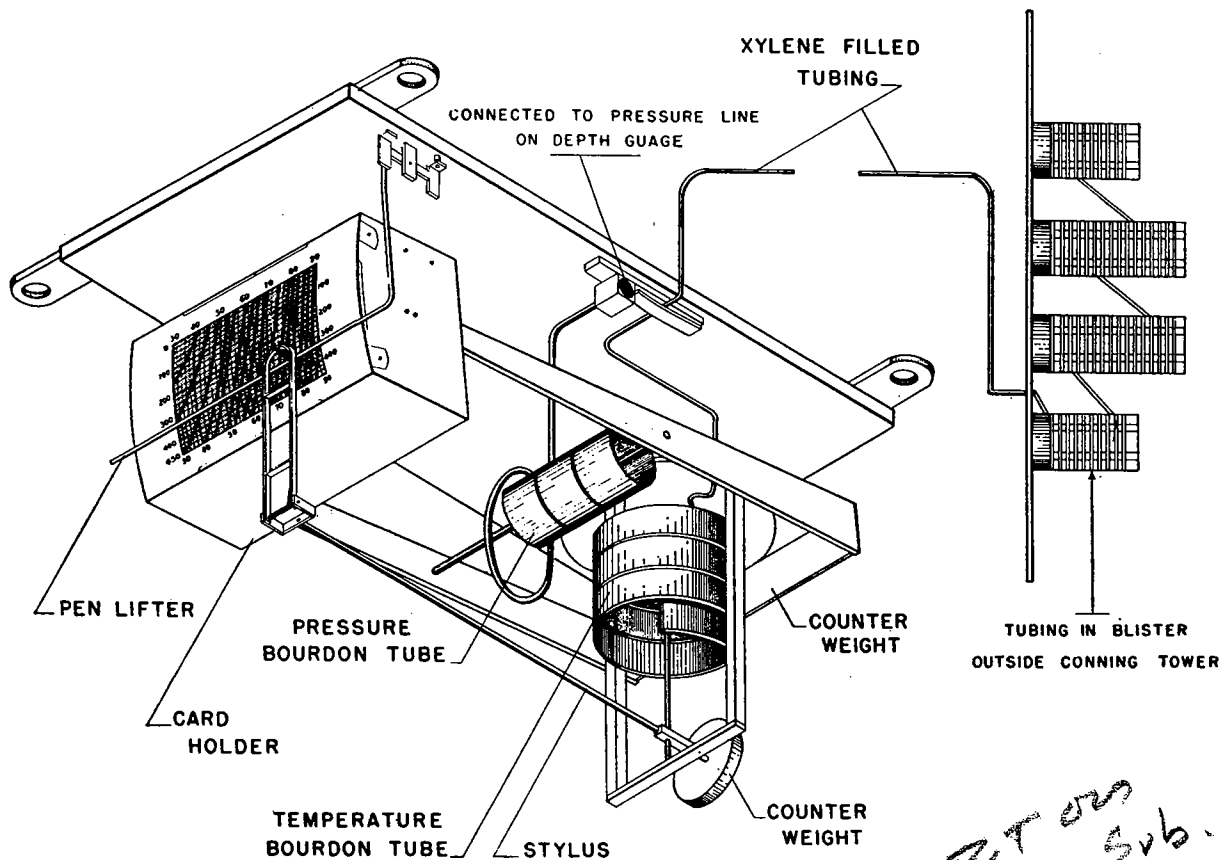

Figure 20. Diagram of submarine bathythermograph.

*BT 025
1942-43 Sub.*

management responsibility for the Bristol Company contract. Allyn C. Vine was consultant and liaison with Woods Hole. The Bureau of Ships drew up specifications, determined accuracy tolerances and let contracts for production in quantity. Submarine Signal Company assembled the first batch of commercial instruments, an order which paid patent requirements. The major quantity came from the Bristol Company, Waterbury, Connecticut, where they were in full production by 1942. Although common commercial practice in temperature devices called for only 3 percent of full scale in recording accuracy, the BT required precision to $\pm 0.1^\circ\text{F}$ at the surface and repeatability of about ± 2 feet in depth. Many original Bristol instruments came close to these specifications. Mass production and wartime changes in metal quality later required some leeway in tolerances. In fact, to produce the great numbers of bathythermographs required, accuracy tolerance below depths of approximately 380 feet had to be reduced. Thus, some of the deeper records are really spread over a greater depth than the slide would indicate.

At the Navy Electronics Laboratory both old and new models of BT's were tested for reliability and evaluated for conformity to BUSHIPS' specifications.^{(19) thru (24)} The Bureau of Ships also made a statistical check of production BT performance

in 1952.⁽²⁵⁾

Wartime shipments were made in narrow wooden boxes (fig. 21A). One BT with swivel and nose-piece, viewer grid, extra grid, and a number of smoked slides were in the box. Other small containers included a can of clear lacquer, lacquer thinner, tweezers, a small Fahrenheit stem thermometer, and an instruction book. Because rough handling caused some of the BT's to become out of adjustment, packing boxes were later made of metal, or lined with molded styrofoam, for maximum instrument protection (figs. 21, B, C).

CALIBRATION

Background

The standard or Navy bathythermograph was a tool for sonar. It was developed as an indicator of temperature gradients, that is, the relative changes in temperature with depth, versus the original concept of completely accurate and repeatable measurements of temperature variation. Relative gradient was needed by the sonar people; all other considerations were minimized. Actual characteristics of each Bourdon tube were so delicate and the elastic movement so individual, that a special grid had to be made to interpret the complicated

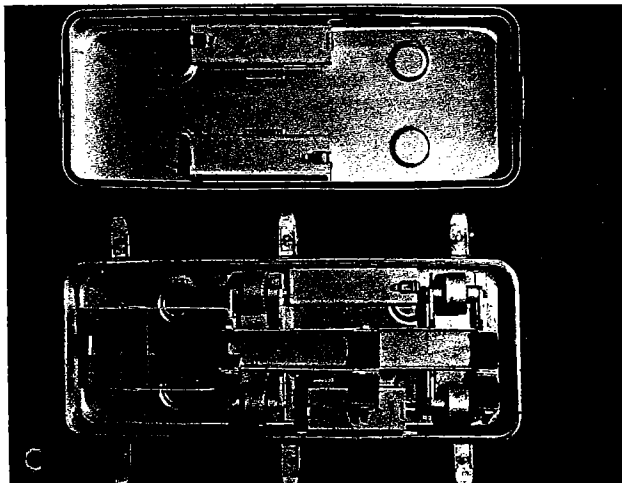
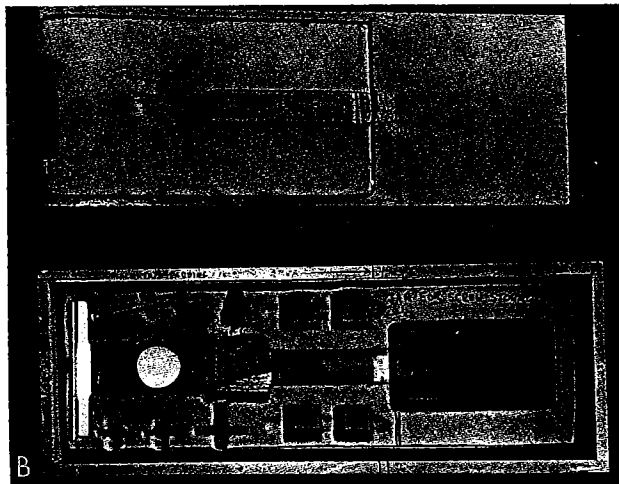
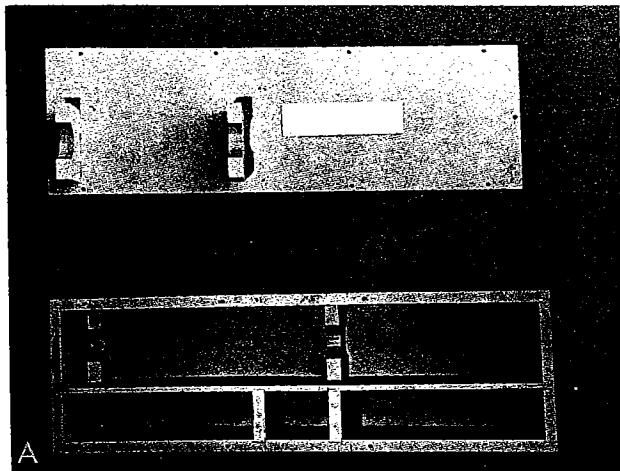

Figure 21. BT shipping boxes
 A. Wooden
 B. Styrofoam-padded
 C. Metal

movement of the stylus. Calibration was an instrument-by-instrument process: one grid or one bathythermogram could not be superimposed over another. For comparison of traces made by separate BT's, each had to be plotted on a standard scale. Although an annoyance, this feature was accepted to keep the instrument "simple," while still obtaining essential sonar information. This concept of a useful tool versus a precise instrument was demonstrated by the fact that during early development grids were calibrated to 80 °F. To make the BT useful for sonar application in the 84 °F water off Florida, it was only necessary to use pliers to bend the stylus arm so the stylus still registered on the glass slide and did not run off scale. Of course, the resulting shift in scales prevented a measure of the true temperature, but the trace, nevertheless, was a useful indication of the temperature gradient - the relative temperature change with depth, the information needed for the military problem.

Two grids for each instrument were supplied by the manufacturer, but the instrument often incurred some damage and needed repair and recalibration. The Navy established three primary calibration facilities at San Francisco, Honolulu, and Boston. Other calibration and testing facilities were maintained at the University of California Division of War Research (UCDWR) (later known as the Navy Electronics Laboratory) in San Diego (figs. 22 A, B) and at Woods Hole Oceanographic Institution. More recently a calibration facility has been established at the National Oceanographic Instrumentation Center (NOIC) in Washington (fig. 22 C).

Procedure

The initial step in calibrating the BT or composing a new viewing grid was production of the calibration slide. This was accomplished by loading several BT's with blank slides and submerging them in a hydrostatic tank in which both the pressure and temperature could be accurately controlled (fig. 22 D). Temperature was regulated by a bridge-type potentiometer in conjunction with a thermopile installed inside the tank and read to 0.1 °F. The tank was first cooled to a near freezing temperature, then the pressure was increased in increments of feet or meters to a pressure corresponding to the maximum depth of the BT. After each pressure increment, the tank temperature was slightly increased to produce "steps" in the stylus trace and thus to mark each depth increment. The temperature was again increased following the last pressure increment, and the system was then permitted to stabilize. At this point, the pressure was released, resulting in a thermal line on the BT slide. Repetition of pressure and temperature changes thus provided a series of thermal and pressure lines on the smoked calibration slide.

In a Woods Hole calibration, six depth and five isothermal lines are drawn by each BT on a calibration slide while in the calibration tank. Starting at (1) on figure 23 and with the tank at atmospheric pressure, the temperature is reduced to approximately 1° above the first isoline (A). This draws the surface (0-depth line from (1) to (2).

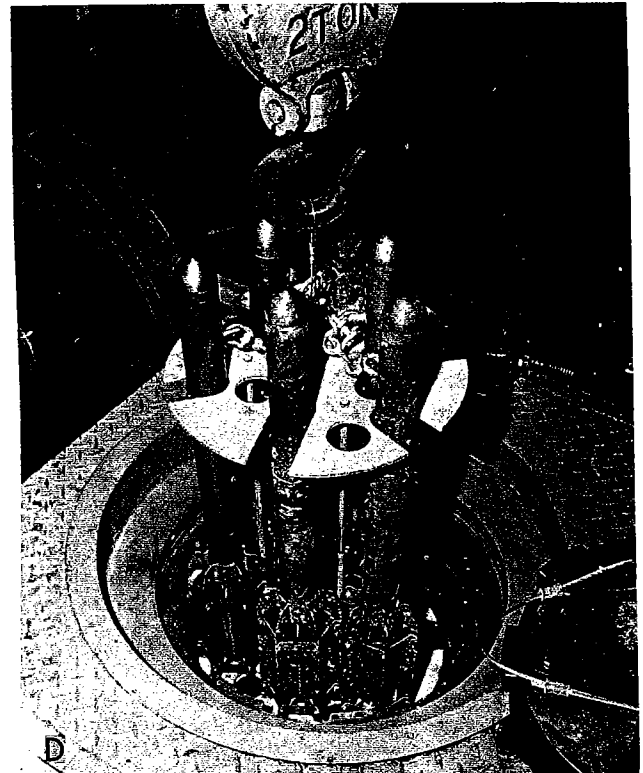
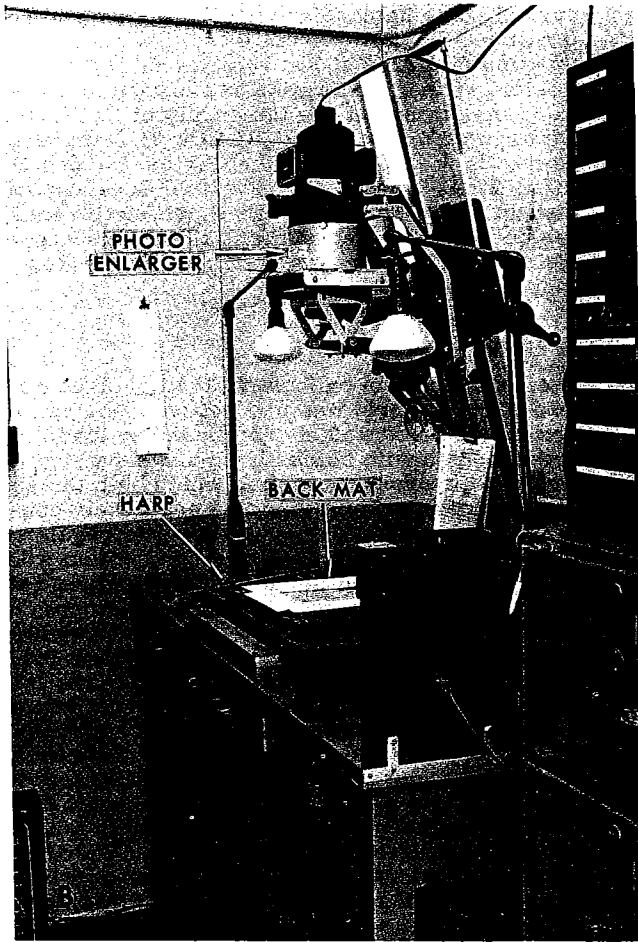
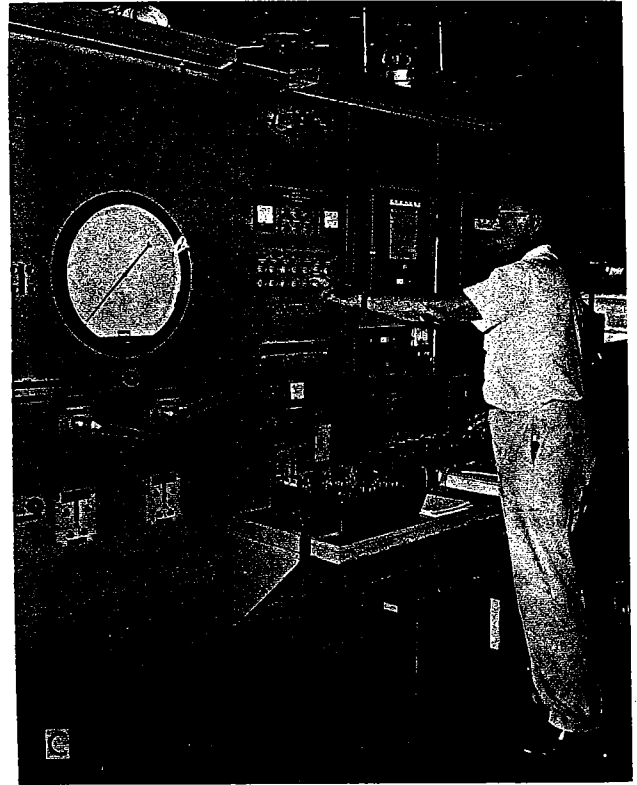
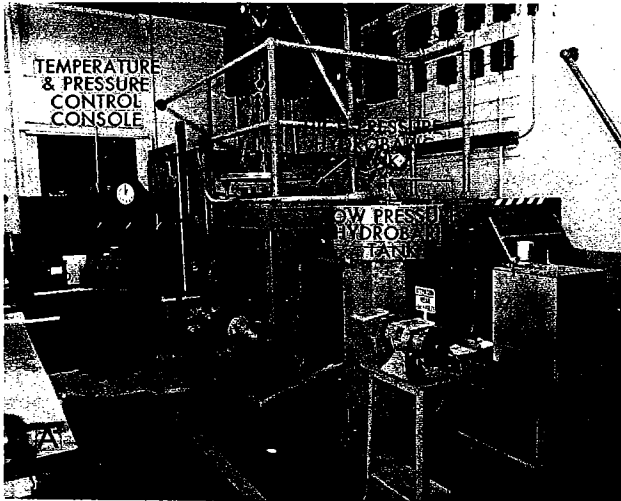

Figure 22. BT Calibration
 A. Calibration facility at NEL.
 B. Equipment used to make BT grid.
 C. Control panel of calibration unit at NOIC.
 D. Loading NOIC calibration tank.

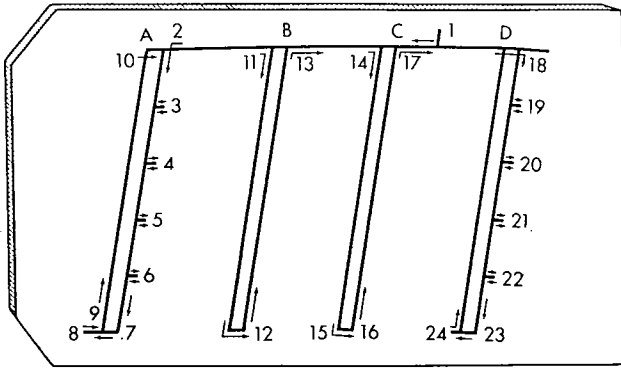

Figure 23. Schematic of BT calibration grid. Isothermal lines are labeled A - D, and pressure (depth) lines are 2 - 7 and 18 - 23.

Holding the temperature roughly constant, the pressure is increased to a chosen depth at (3). Holding the pressure constant, a short line is drawn by increasing the temperature. The tank is allowed to cool by the amount of the small increase; pressure is then increased to (4). The procedure is repeated to a chosen high pressure limit at (7) where the temperature is allowed to cool by approximately 2° to (8). Pressure is then carefully increased again to (9). At (9) the pressure is slowly and smoothly reduced to zero, drawing the first isoline at (A). The temperature is increased approximately 10° to (11); the pressure is increased to the previously chosen high pressure; and a little heat is applied to raise the temperature to (12). Pressure is then slowly and smoothly reduced, drawing isoline (B) from (12) to (13). The process continues as shown, with six depth marks made between (18) and (23), and the final isoline (D) being drawn from (24) to the surface.

Viewing Grid.

The viewing grid was made by adapting an adjustable temperature-depth grid to the calibration slide. The calibration slide was placed in a photo enlarger and projected on a white back mat, producing an enlarged image (fig. 22 B). Temperature graduations (vertical lines) were provided by means of an overlay device composed of adjustable, evenly spaced, parallel wires. This wire-strung pantograph looked somewhat like a harp. Spacing between the wires was adjusted until thermal lines on the calibration slide coincided with corresponding temperature graduations on the "harp" (fig. 24). Depth lines were provided by a series of back mats consisting of a selected set of curved (arc) lines with various curvatures and spacings, a card being chosen so the depth lines coincided with the depth steps on the calibration slide. Suitable depth and temperature scales were placed in position on the sides and top of the mat, and the BT identification and date of calibration were in the lower left-hand corner.

The calibration slide was removed from the slide holder in the enlarger, and replaced with a glass photographic plate of the same dimensions. The

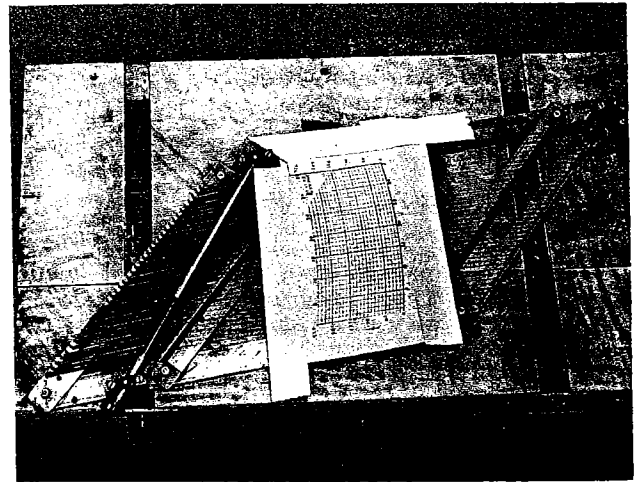

Figure 24. "Harp" and back mat used to make temperature and depth lines on BT grid.

plate was now exposed, removed from the holder, and developed, producing a photographic negative of the grid. From this negative, positive grids were made on clear glass slides of the same size. The positive grids were next dipped in lacquer for preservation, and then cemented in an adjustable slide holder. The calibration slide was placed in the metal slide holder, and the stops were adjusted so the depth and temperature lines of the positive grid coincided with those of the calibration grid. In later versions, set screws were added to make the final adjustment (fig. 25). This mounting frame was attached to a magnifying lens, called a viewer, for immediate reading of a slide by the sonar officer (fig. 26 H). Two positive grids were made for each BT. The calibration slide and negative grid were filed for future reference. Each

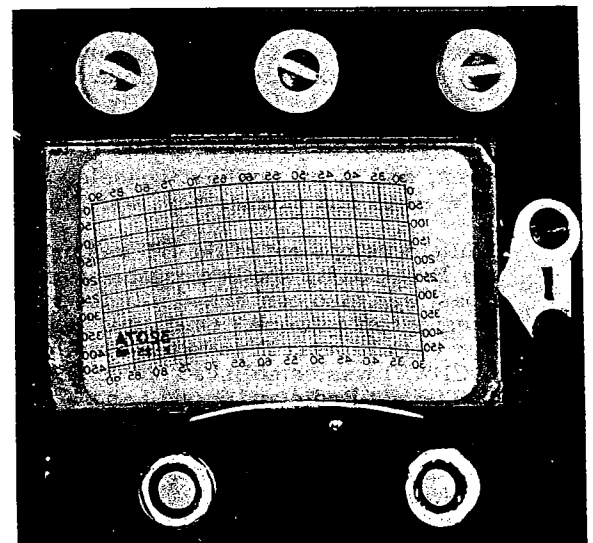

Figure 25. Printed side of BT grid in holder.

time a BT was repaired and recalibrated, the letter following the serial number was changed to the following letter of the alphabet for indication of which grid applied to a particular BT at a particular time.

TRAINING PROGRAMS

Introduction of new oceanographic equipments in the Navy necessitated development of training programs. These programs included the use of submarine, as well as surface vessel BT's. Much of this work was done through a liaison officer, then CDR Roger Revelle, on duty at both the Bureau of Ships and the Navy Hydrographic Office, with assistance from CDR Marston Sargent and LCDR Mary Sears. Before Pearl Harbor the first 10 of an eventual 30 naval officers were sent to Woods Hole for training (see Appendix A). Under the direction of Ewing, Iselin, and the Woods Hole staff, these ensigns were taken to sea, taught to make lowerings and read slides, and given the rudiments of sonar propagation as it is affected by refraction.

Immediately after Pearl Harbor and formal entrance into World War II, the ensigns were assigned to the Atlantic or Pacific Fleet to introduce a new concept, based on the temperature structure in the sea, in antisubmarine warfare. They were initially given one winch, one spare roll of wire, one bathythermograph, a box of slides, a can of clear lacquer to preserve the slides, and instruction materials. After the first few lowerings under operating conditions, frequently using wooden booms and wire that frayed, the first fleet bathythermographs virtually disappeared; however the officers, whenever possible, continued the work for which they had been trained and equipped. They made fine combat records; one was awarded the Navy Cross for heroism and several were war casualties.

As the war shifted to the Pacific, the Fleet Maintenance Office of the Service Force, Pacific Fleet, set up an installation and training unit at Pearl Harbor under Lt (later CDR) B. K. Couper, who coordinated activities of the Pacific military BT specialists. The officers were given new equipment, and many auxiliary vessels, in addition to ASW ships and submarines, were instrumented.

While development of the BT was progressing on the East Coast, another organization on the West Coast was also concerned with the BT and related oceanographic work. On 1 July 1940, the University of California Division of War Research (UCDWR) was established on the grounds of the U. S. Navy Radio and Sound Laboratory at San Diego, California. The oceanographic section of UCDWR was composed of a group from the Scripps Institution of Oceanography, originally headed by Dr. H. U. Sverdrup, followed by Dr. R. H. Fleming, and later by Dr. E. C. LaFond when the laboratory became NEL. Its primary purpose was naval oceanographic research. One of the divisions at UCDWR was concerned with the training problems involved in introducing new oceanographic equipments into the Navy.

The civilian training programs on both coasts were very effective, and men with a wide range of talents were recruited. Talent was used wherever found. Even biologists and astronomers were trained and became instructors, teaching others to install bathythermograph winches, take observations, read slides, and apply the information to sonar ranges.

TRAINING MANUALS

Instruction materials, which presented Naval and sonar procedures, as well as the new oceanographic concepts were expertly prepared at UCDWR. One of the first editions of the BT Range Prediction Manual was largely written by the well-known astronomer, Dr. Lyman Spitzer. (He also coordinated inter-laboratory programs.) Although serious in nature, comic strip art and cartooning were deliberately employed to catch attention and stress important points.

One manual was concerned with handling of the bathythermograph.⁽²⁶⁾ The proper procedures in making a BT lowering are shown in figure 26, parts A through H. Surface temperature, for instance, was obtained by dipping a bucket into the water (fig. 26 D), and then quickly measuring its temperature with a stem thermometer. Measurements were normally estimated to ± 0.1 °F by this method. On high-speed military ships, the temperature of the water in the main condenser intake was used, usually with a considerable reduction in accuracy. The recorded surface temperature was the primary independent field check that could be made on a BT's performance.

Despite the hazards of operating the BT (fig. 27, parts A through D), difficult lowerings were made on time and records were kept. Danger points were also described in the manufacturer's instruction book; among the instructions were warnings not to: "lower the BT while the ship is expected to turn;" "lower unless the water is deep enough;" "leave in a temperature greater than 105 °F;" "bump, drop, or jar."^{(26) (27)} However, loss of BT's was still high. Their deployment offered innumerable opportunities for making mistakes: putting the slide in upside down; failing to pull back the sleeve; lowering too deep, and so forth. Despite reporting of the intended BT lowering to the bridge, the message was not always received, and the ship would turn, causing the wire to foul the propeller. Probably the greatest hazard was a swinging BT after it left the water. A familiar saying was: "sight, surface, oh that son of a gun," or words to that effect, as the instrument swung in circles around the boom. The BT can make hundreds of successful lowerings with excellent results, but it is still a delicate instrument which can be easily damaged (fig. 28).

One of the most interesting instruction booklets, the "Manual for Bathythermograph Pilot Instructors"⁽²⁸⁾ presented a whole spectrum of antisubmarine warfare subjects. Not only did it give the technique and uses of BT's, but also such useful knowledge as how to tell the difference in rank between an ensign and a captain. Another manual

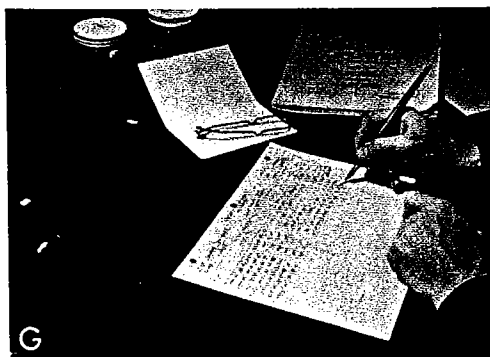
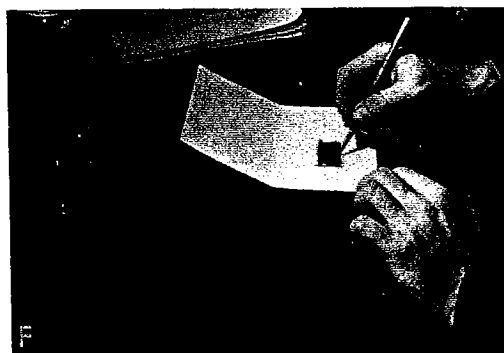
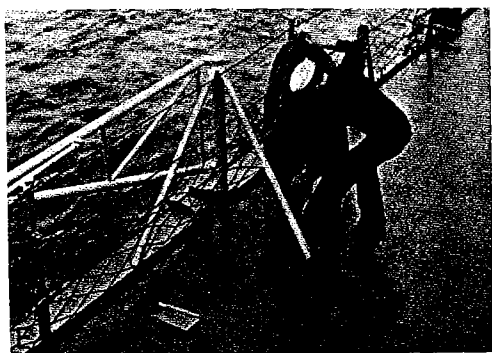
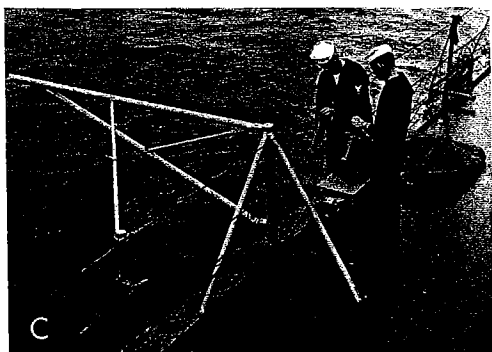
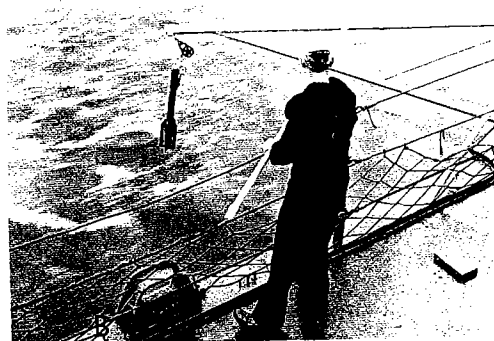
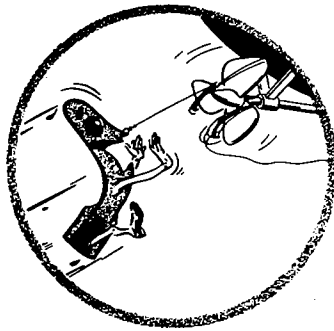
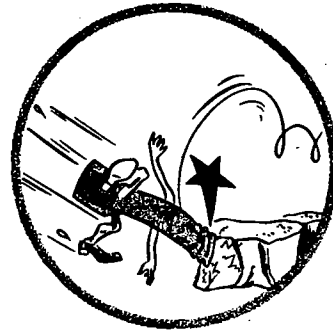

Figure 26. Procedure used in making bathythermograph observations.

- A. Inserting BT slide in slide holder.
- B. Swinging out gate boom.
- C. Level winding wire on drum.
- D. Taking bucket of water for surface temperature.
- E. Protecting winch with canvas cover.
- F. Labeling slides.
- G. Entering data on BT log sheets.
- H. Reading trace on BT slide.



KEEP WIRE OUT OF SCREW



KEEP BT OFF BOTTOM

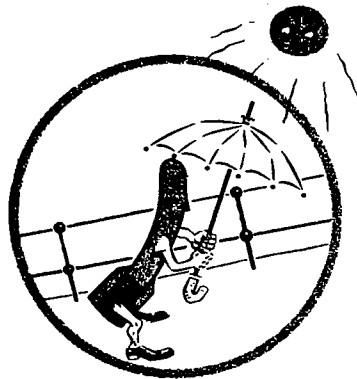

KEEP BT COOL

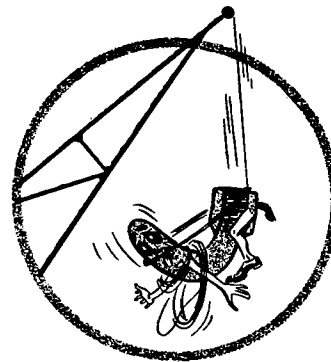

AVOID FOULING WIRE

27. Bathythermograph operational hazards.

furnished a set of BT reference slides,⁽²⁹⁾ these instructions were later incorporated and widely distributed.^{(30) (31)} Similar manuals were produced for the use of submarine bathythermograph data,^{(32) (33)} and they also covered a variety of subjects. Some illustrations from the section on "Operational Uses," covering the tactical functions for which the BT and SBT furnished useful information, are reproduced in figure 29.

USE OF BATHYTHERMOGRAPHS AND BATHYTHERMOGRAMS

Background

The original scientific purpose of the Spilhaus bathythermograph was to study the wind-stirred layers of the sea, a subject of interest to meteorologists concerned with ocean-air interaction as a common dynamic system. It was also realized that the temperature data themselves, even though relative rather than exact, were of extreme importance in indicating the variability of temperature structure, with respect to time and space, and should be preserved.

Thus, when bathythermograph slides from the improved BT were received at Woods Hole, the

procedure for reproducing and analyzing the data became the concern of Dr. R. B. Montgomery, who established a system for making correction

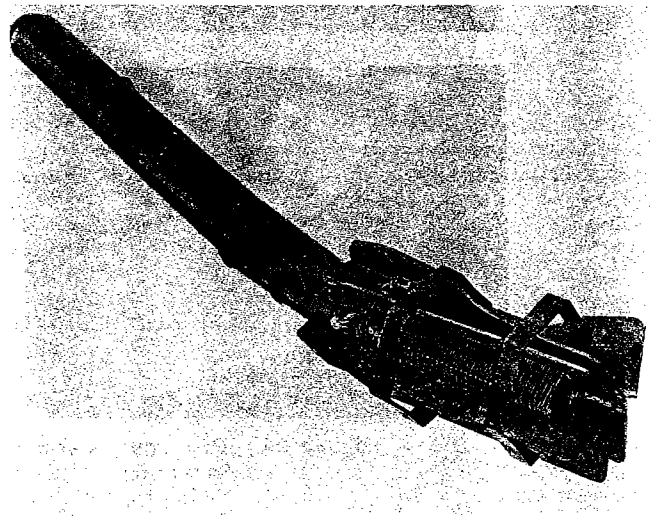
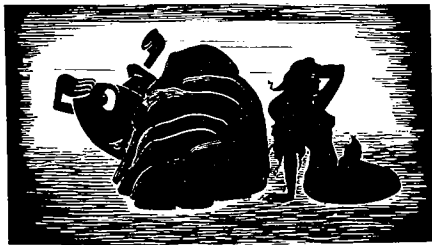
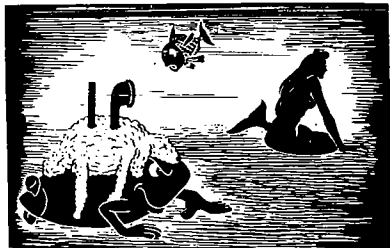

Figure 28. BT's are easily damaged.



SEARCH



APPROACH



ATTACK

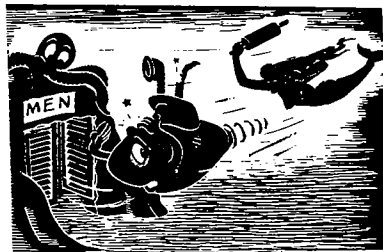

EVASION

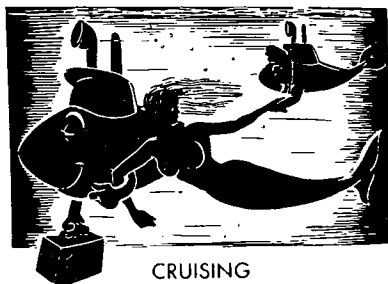

CRUISING

Figure 29. Training manual topics covering tactical use of BT's and SBT's.

adjustments, accurate reading, and archiving data by photographic means.

Although later streamlined for production purposes, the essential notations and BT data corrections were established at an early date.

Meanwhile, military interest expanded from spot observations to use of the data in preparing sonar charts. On the East Coast, Martin Pollak compiled all available Atlantic Ocean hydrographic station data from the Marine Biological Library in Woods Hole. These data, combined with increasing numbers of Atlantic bathythermograms, were reduced to cards. A BT data bank and processing group were set up under direction of Norman T. Allen.

On the second long BT cruise of the R/V ATLANTIS from August to September 1941 (under command of CAPT F. S. McMurray with B. K. Couper aboard as a technician) over 1000 BT lowerings were made under direction of Alfred Woodcock in the Atlantic Ocean (the Grand Banks, New Foundland Basin areas, and southward). This volume of slides immediately emphasized a data-handling problem. Later, with several hundred ships equipped with BT units, the acquisition of BT data, especially by the Navy, required establishing formal and adequate processing units. A Navy directive required ships taking BT data to send them to either the Radio and Sound Laboratory in San Diego or to Woods Hole. This was the beginning of a program which was to become the greatest oceanographic survey of its type and it was accomplished during wartime conditions. In fact, it was possible to plot the progress of the war by the locations and dates of the bathythermograph stations across the Pacific. Data collected in April, in all years prior to 1946, are shown in figure 30.

Data Processing

Handling the slides and data sheets involved considerable effort. The fact that the mechanical BT required its own individual grid led to the development of a rather unique and expensive system of data processing. Because of the time element, it was necessary to process rapidly so the information, in the form of sound ranging charts, could be quickly given back to the fleet. Maximum accuracy was also requisite, not only for the fleet, but for anticipated future analysis. Although differing in minor details, the basic steps in recording, plotting, correcting, photographing and filing were established on both the east and west coasts and personnel were trained to do the job.⁽³⁴⁾⁽³⁵⁾ Because of the size of the Pacific Ocean and the remoteness of the naval operations in that area, the amount of data acquired by UCIDWR was proportionately greater. This processing and charting group was headed by E. C. LaFond.

As soon as the slides were received at the Navy Radio and Sound Laboratory, receipt was acknowledged to the sender and they were checked for reliability.⁽³⁶⁾ Some slides were broken, position notations were perhaps interposed, and some BT traces were made with pencil rather than by the bathythermograph stylus. After this logging, an

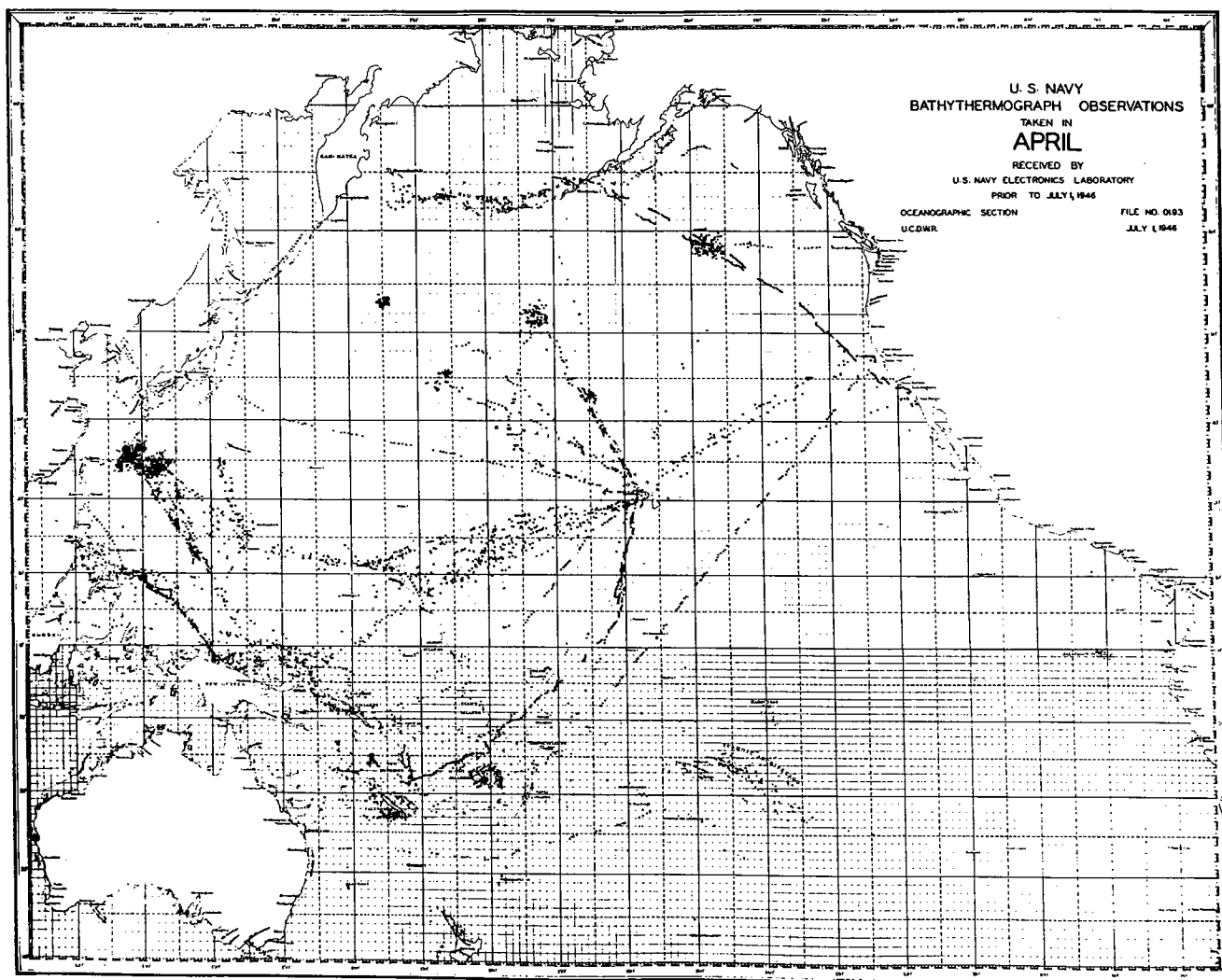

Figure 30. U. S. Navy bathythermograph observations taken in April in North Pacific prior to 1946, showing the location of BT stations along ship tracks, clusters around weather station and areas of most ship activity.

adjustment was established for actual temperature and depth. This was done by placing the set of slides against its grid and comparing the surface temperature values from the trace with the surface temperatures recorded on the corresponding data sheets (measured by means of a bucket and stem thermometer or by the ship's injection temperature). An average temperature correction was applied to the set of slides by adjusting each slide with respect to its grid. They were then corrected for depth by matching the recorded surface trace with the zero line on the grid. After corrections were made in an adjustable holder, the grid and BT slide were projected as a negative in a photographic enlarger. Light projecting through the slide and grid onto a double-weight, 3 x 5 inch photographic card resulted in a print in which the BT trace showed black against a white grid (fig. 31). The backs of the prints were stamped with a ruled form which allowed space for relevant information such as ship, position, date, time, weather, and

so forth. Two copies were tediously handwritten and checked. One copy was sent to the Hydrographic Office (now to NODC), and one copy was retained for further analysis. Files were set up for the glass slides as well as for the prints (called bathythermograms). The various steps in processing of BT data are shown in figure 32, parts A through F.

Sonar Ranges

Sonar ranges were determined from the use of tables which were computed largely on the basis of ray diagrams.^{(37) thru (40)}

Slide rules were developed for rapidly calculating refraction effects and relative sound intensities.^{(41) (42)} Based on ray theory, these were widely used to analyze, in detail, sonar conditions from BT data. As soon as data were processed, they were grouped into four categories according to their

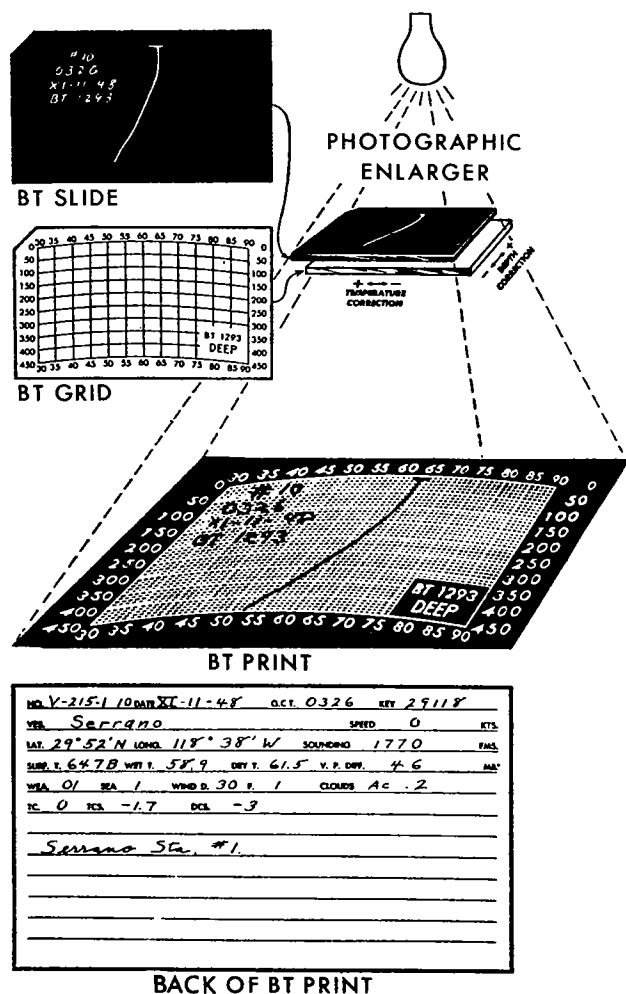

Figure 31. Procedure used in making bathythermograms.

temperature-depth gradients and read for sonar ranges.⁽⁴³⁾⁽⁴⁴⁾ When the temperature change in the top 30 feet was 0.3 °F or less, the water was considered mixed, and the pattern was called "MIKE." These conditions were usually conducive to the formation of long sonar ranges, especially if the mixed layer was deep. When the temperature difference was greater than 1/100 of the surface temperature (in °F), the computed range to the shadow boundary was very short. Such a strong negative temperature gradient was called "NAN." Weak temperature gradients, intermediate between MIKE and NAN, tended to be variable and changing and were called "CHARLIE." The fourth type of pattern existed when the BT temperature was greater at a depth below the sound-source projector than at the source depth. This caused the sound rays to be refracted upward, usually resulting in short ranges. When such positive gradients were present, the temperature pattern was called "PETER" (fig. 33, parts A through D).

A variety of combinations of these patterns was possible. In some cases, for example with NAN and PETER patterns, near surface sound channels developed which would extend the range. The

shape of a BT trace could be considered as exerting a beneficial or detrimental influence on sound rays, depending on depth of the sound source (fig. 34). Tables covering the different sonar range categories and numerical codes for analysis and transmission of BT and sonar data were developed.

Sonar Message

The usual practice was for one ship in the task force to take a bathythermograph lowering, determine the BT characteristics and sonar range, and then transmit the information to the other ships. Numerical codes were also developed for this purpose. Although the word bathythermograph was soon abbreviated to BT, this could not be used in a radio message because it was already used to mean a separation of the heading from the text. It was, however, necessary to communicate the information derived from BT lowering to other ships. This was called the "BT message," and was an essential communication link. Information on BT temperatures, wind, depth, and even sediment type (in shallow water) were needed to compose the message. Pertinent reminders are illustrated in figure 35.

Sonar Charts

The possibility of charting the prevalent condition of the wind-stirred, near-surface layers by ocean areas and seasons was early recognized by oceanographers. The immense amount of data collected by naval vessels was valuable for studies of the geographic, seasonal, and diurnal variations of temperature gradients near the surface. The studies led directly to the preparation of sonar charts and estimations of the relative importance of different types of temperature conditions in areas in which the fleet was operating. It was possible to show the relative importance of solar heating, evaporation and cooling, and the effects of wind mixing, from this, procedures could be developed by which the progressive change in sound conditions could be estimated. On the basis of established tables and hydrographic data, both the periscope depth and assured range, as well as the diurnal changes, were computed from each BT slide.

These data were then grouped geographically, usually by 1° quadrangles, and ranges were contoured for the three major oceans. Accuracy increased and procedures were modified as a better knowledge of the effect of thermal structure on sonar range, together with increased amounts of data, became available. All BT's, SBT's, serial station, and hydrographic information were used. Charts were compiled at 6-month intervals, alternately for winter and summer conditions, and for the North Pacific, South Pacific, North Atlantic, South Atlantic and Indian Oceans. Individual monthly conditions were later included by addition of superimposed histograms. Those for the Atlantic Ocean were prepared under Fritz Fuglister and those for the Pacific and Indian Oceans by E. C. LaFond. When completed these charts were printed by the Hydrographic Office, and issued to the Fleet. Seven editions (1942 through 1945) of sonar charts based on BT (and serial station) data,

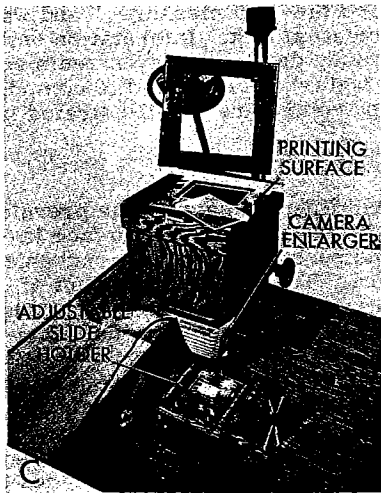
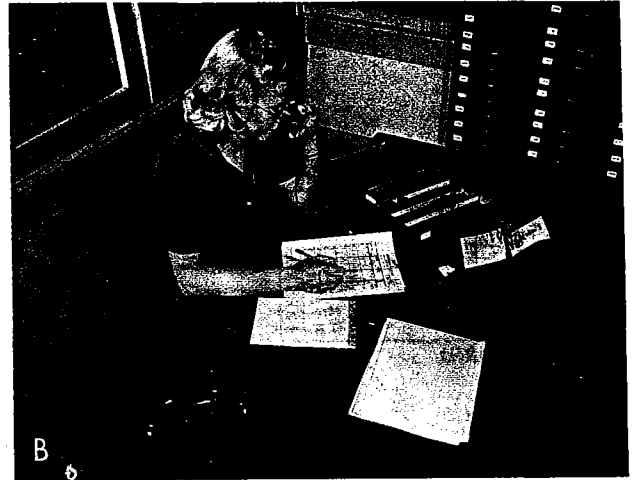
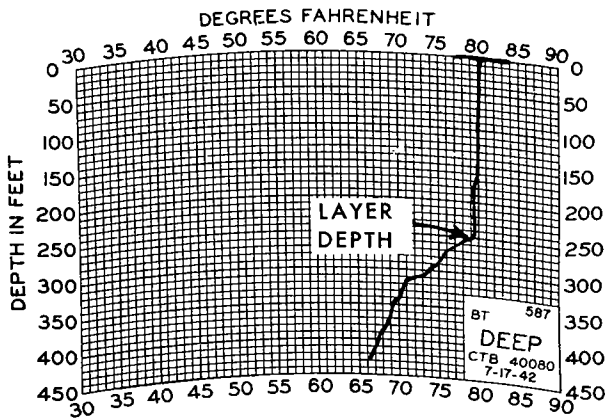
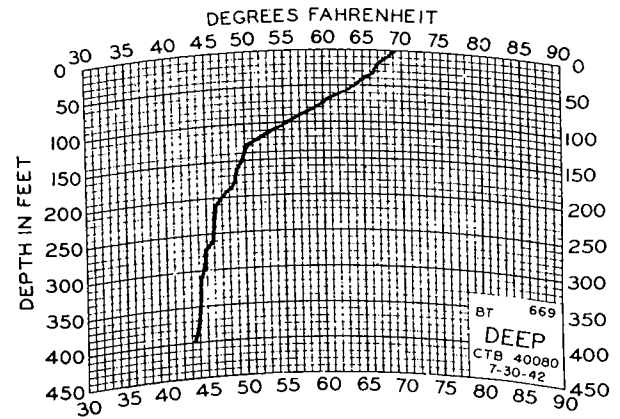

Figure 32. Steps in BT processing.

- A. Pat Clarkson, Lila Schroeder, and Barbara Root checking incoming BT slides and log sheets, in UCDWR Building X.
- B. LaFay Porter reading BT slides for temperature adjustment.
- C. Copying equipment for BT slides.
- D. Mildred Hunter making photographic prints of BT slides.
- E. Transcribing data on back of bathythermograms.
- F. Barbara Rimbach filing BT slides.



A. MIKE



B. NAN

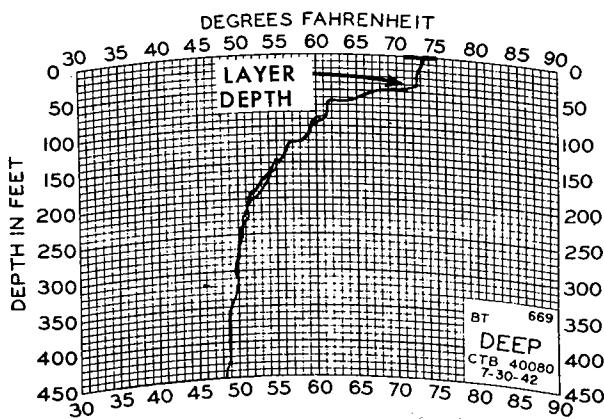

C. CHARLIE

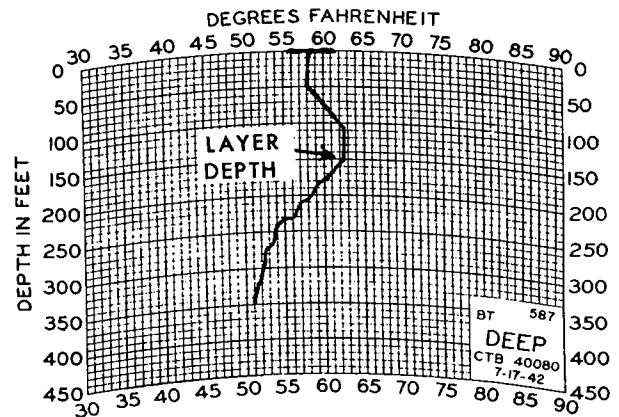

D. PETER

Figure 33. Four types of bathythermogram patterns.

- A. Mixed surface layer.
- B. Weak near-surface temperature gradient with depth.
- C. Strong near-surface temperature gradient with depth.
- D. Temperature increase with depth.

covering the five areas and numbered H. O. No. 1400R, 1401R, 2500R, 2601R, and 2603R, were issued (fig. 36).⁽⁴⁵⁾

In shallow water the type of sediment, that is, mud, sand, or rock, influenced transmission loss. Sonar charts were thus complemented by bottom sediment charts prepared by UCDWR and Woods Hole. A group, including Drs. F. P. Shepard and K. O. Emery on the West Coast and H. C. Stetson on the East Coast, produced dozens of these colored sediment overlays for existing navigation charts. The charts, printed by the Hydrographic Office, were based on all the sediment data available - mud, sand, hard or soft bottom, and so forth. Many of the sample notations had come from lead lines. Thus, in estimating a sonar range it was necessary to know not only the temperature gradient, as determined from the BT, but also water depth, bottom type and meteorological conditions. The important point, however, is that the evolving

and developing scientific descriptions of the sea were being turned into useful military tools and vice versa.

Other Uses of BT Data

Rosby's original "oceanograph" was developed to study the characteristics of the mixed layer. With improved versions of the bathythermograph and its expanding use, it was evident that a voluminous and valuable collection of data was being acquired. Thus, a spinoff of the UCDWR BT processing group was the BT analysis group.

Near the end of the war (in 1945), this group and the large collection of bathythermograms were transferred to Scripps Institution of Oceanography where thermal structure studies were started under E. C. LaFond. In 1946, the processing activity was also transferred to Scripps, combined with the analysis group, and successively headed by Dale

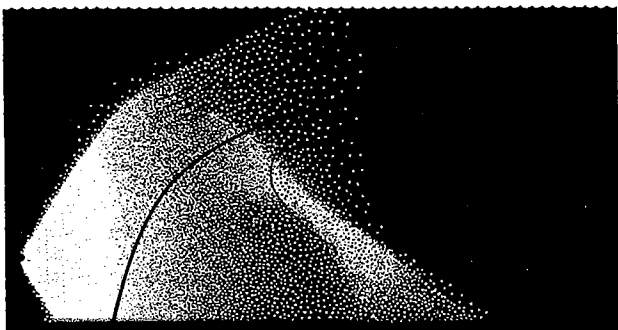
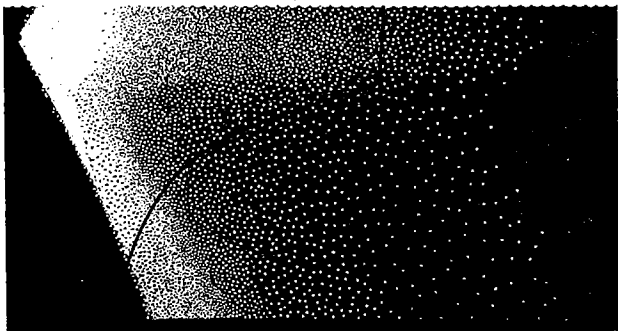

Figure 34. Temperature structure may be detrimental or beneficial to sound rays depending on the depth of the source.

Leipper, Wayne Burt, John Cochrane, and currently Margaret Robinson. A great deal of processing and subsequent analysis has continued, especially at Scripps, Woods Hole and Naval Oceanographic Data Center.⁽⁴⁶⁾⁽⁴⁷⁾ Much of the BT data have now been digitized and put on magnetic tape by NODC.⁽⁴⁸⁾

Up to 1968 BT data were digitized by eye. Since then a machine which automatically traces analog BT traces has been developed by P. R. Mack under the supervision of J. D. Frautschy and M. C. Sargent at Scripps. The current rate of digitization with the machine is 50,000 traces per year. Much of the BT data can now be quickly retrieved, or the positions of all archived BT stations can be automatically plotted (figs. 37, 38, 39).

The greatest concentrations of BT data stations are on navigation routes between major ports and near the coasts of the U.S., Europe, and east Asia. Observations are still being taken by 32 foreign countries and sent to NODC. Within the United States, 40 organizations have contributed to the current collection of 1,300,000 BT observations (see Appendix B).

Although the accuracy of these data is not always as good as desired, they have proven extremely useful to both the Navy and others in understanding



TEMPERATURE GRADIENT

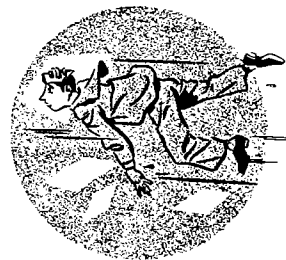

WIND FORCE



WATER DEPTH



BOTTOM TYPE

Figure 35. Information required to prepare BT message.

water structures and the physical, chemical and biological processes which occur in the upper layers of the sea.^{(49) thru (51)} For instance, the correlation between time-lapse photographs of moving slicks and BT layer-depth information established

the relationship of surface slicks to internal waves.⁽⁵²⁾⁽⁵³⁾ Even in meteorology, heat transfer can be more accurately established with BT data. One tabulation⁽⁵⁴⁾ listed 700 reports based wholly or in part on bathythermograms. Even this number represents only the U.S. and Canadian output, and does not include a comparable number of reports from other countries.

FUTURE OF BT'S

Mechanical bathythermographs are available from several manufacturers, many from WW II still operate, and foreign use is still expanding. But for the faster naval ships, the expendable BT is being used more. This instrument can provide temperature information to a greater depth in greater detail, and it can be used in rough weather, however for depth accuracy, the mechanical BT is probably better. For the continuous two-dimensional thermal structure of the upper 750 feet of the ocean, the thermistor chain now provides the best data.⁽⁵⁵⁾ The mechanical BT is still economical, and, with tighter budgets, its useful life is expected to be extended indefinitely. But, the great boom in mechanical BT production and data collection has passed.

ACKNOWLEDGEMENTS

The authors gratefully acknowledge the help of A. F. Spilhaus, W. M. Ewing, S. F. Hodgson, F. Fuglister, V. A. Covello, Margaret Robinson, and I. Perlroth in furnishing information, of Katherine LaFond and Jane Mackenzie for constructive suggestions, of Althea West for the typing, and of Donna Buckner for drafting. They also thank the original group of naval officers who made the BT system work.

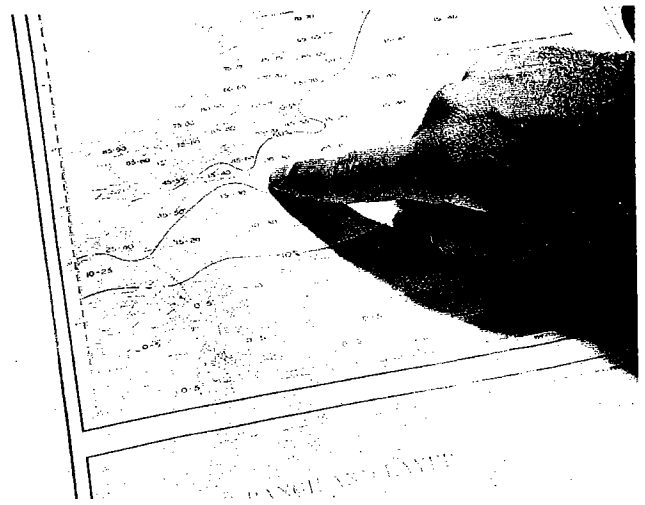

Figure 36. Portion of sonar chart showing Periscope Depth Range in percent of time the range is less than 1500 yards in morning and afternoon.

REFERENCES

- (1) Spilhaus, Athelstan F., "A Bathythermograph," *J. Mar. Res.*, Vol. 1, pp. 95-100, 1938.
- (2) Bennett, R., "Oceanography and the Bureau of Ships," *BUSHIPS Memo*, June 1952.
- (3) LaFond, E. C., "Afternoon Effect and Its Application to Sound-Ranging Charts," *UCDWR Report No. U357*, University of California Division of War Research, 15 September 1945.
- (4) Spilhaus, Athelstan F., "Man in the Sea" p. v-xi, in *1st U.S. Navy Symposium on Military Oceanography*, U.S. Naval Oceanographic Office, 17-19 June 1964.

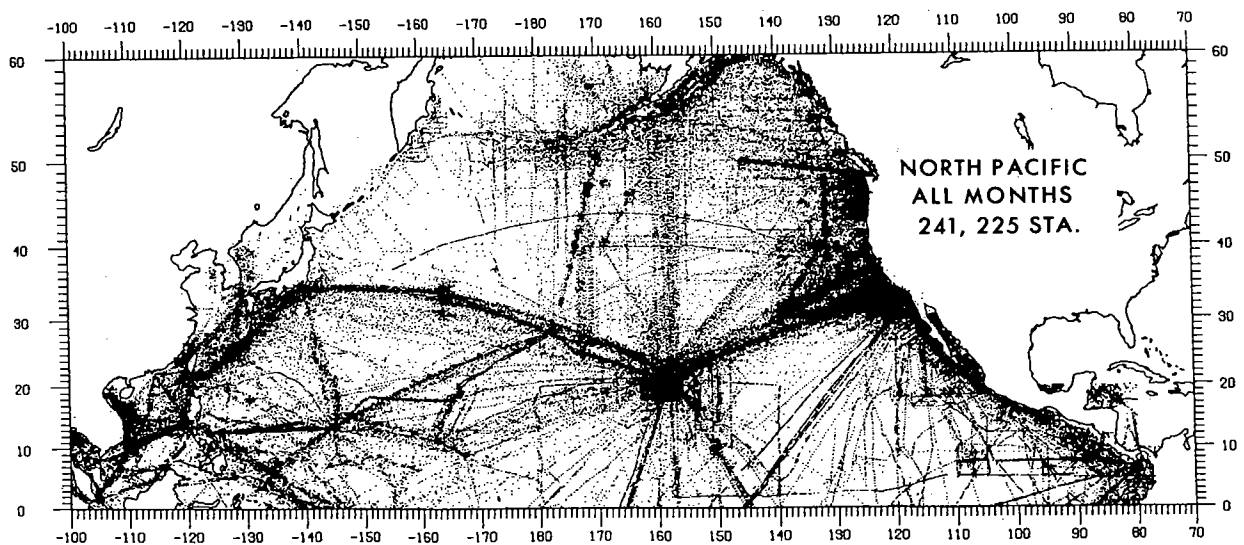

Figure 37. Positions of all processed bathythermograph stations in the North Pacific (prior to 1969) (NODC).

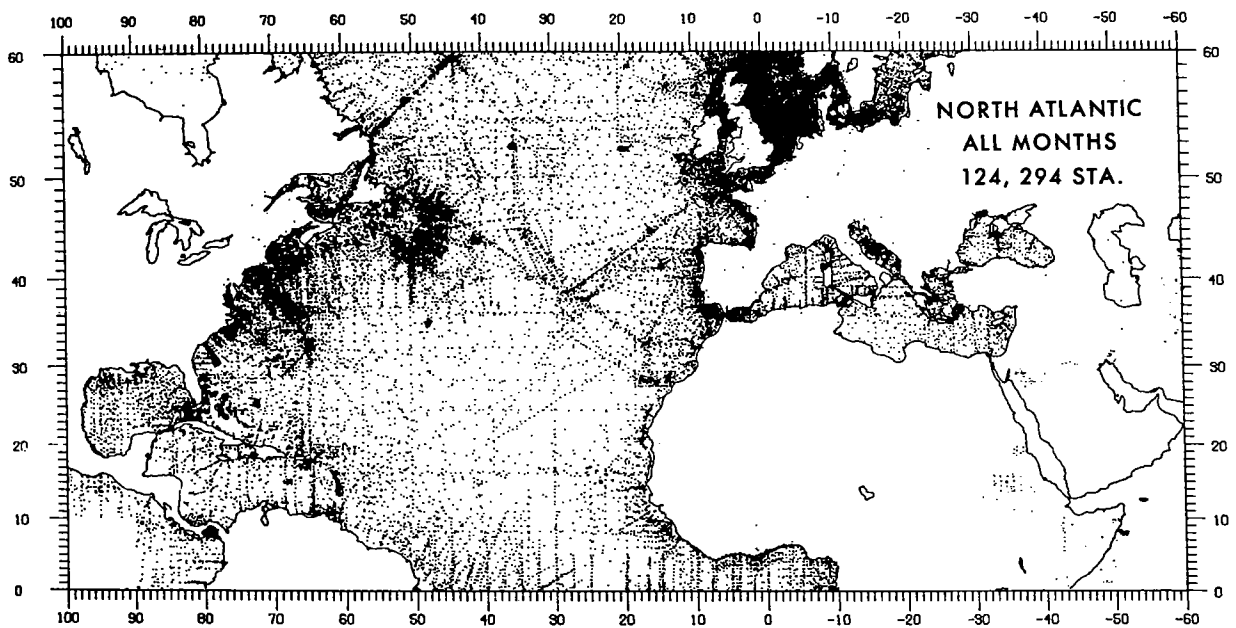

Figure 38. Positions of all processed bathythermograph stations in the North Atlantic (prior to 1969) (NODC).

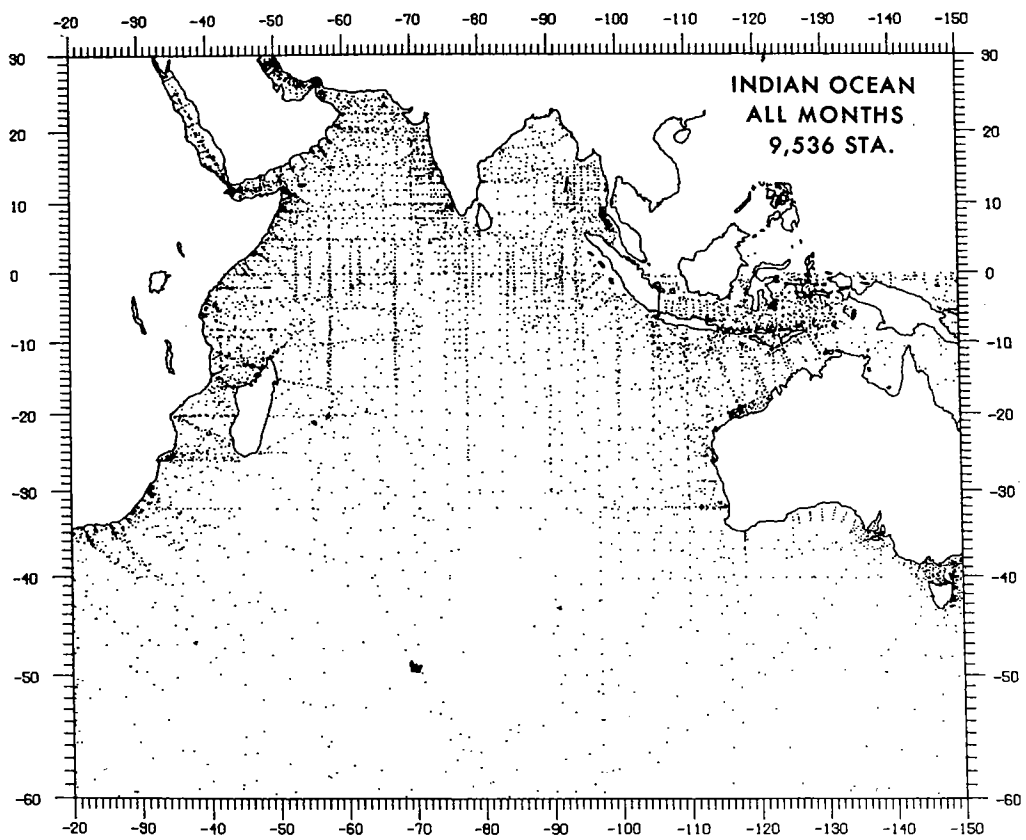

Figure 39. Positions of all processed bathythermograph stations in the Indian Ocean (prior to 1969) (NODC)